



LOW-PROFILE 5C, 16C & 3J WORKHOLDING LINEUP

- CNC COLLET CHUCKS AND KEY-OPERATED MILLING FIXTURES
- USE TRADITIONAL SPRING-TYPE COLLETS
- 5C STEP AND EXPANDING COLLETS





ROYAL LOW-PROFILE 5C, 16C AND 3J ACCU-LENGTH™ CNC COLLET CHUCKS

High RPM

All Royal CNC collet chucks are balanced by design for high-speed operation, and can often be run at higher speeds than conventional 3-jaw chucks because they are less prone to the negative effects of centrifugal force.

Spindle Bearing Protection

An oversized flange acts as a coolant slinger to protect lathe spindle bearings from contaminants.

Bolt & Go™

Our exclusive Bolt & Go™ mounting feature is standard on all Royal Low-Profile Collet Chuck models. Bolt & Go™ enables chucks to be mounted very quickly and ensures maximum accuracy and rigidity. See page 10 for additional information.

Completely Sealed

Lubricated for life, these chucks incorporate multiple O-ring seals to keep contaminants out and prevent chip pack-up on bore-thru applications.

Easy Installation

All Royal Low-Profile Collet Chucks include a collet wrench, mounting hardware, mounting wrenches, and a custom-machined drawtube connector for **hassle-free installation**.

Note – Collets sold separately

Dead-Length Operation

Royal Accu-Length™ CNC Collet Chucks incorporate **dead-length operation to eliminate part pullback**. With this design, a tapered sleeve pushes forward over the collet to compress it, resulting in precise z-axis positioning.

Outstanding Rigidity

All Royal Accu-Length™ Collet Chucks have been optimized for maximum rigidity, and all components are hardened for strength and durability.

Low-Profile

All external dimensions have been optimized to provide maximum tool clearance.

High Accuracy

All Royal Accu-Length™ CNC Collet Chucks are guaranteed to run within 0.0002" TIR.

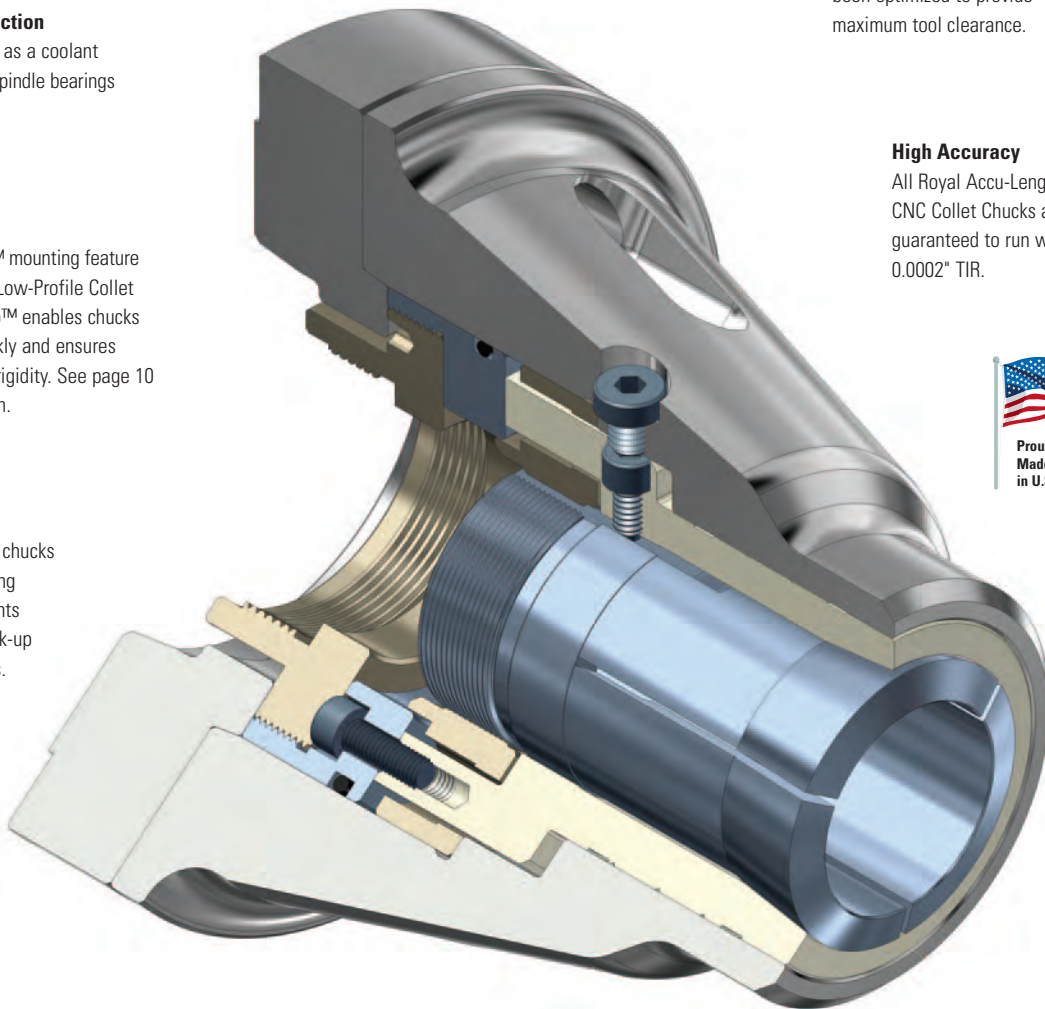

Specials

If you have a special application that goes beyond the scope of our standard line, we will be happy to design and build a custom system to meet your needs. Please contact a Royal applications engineer to discuss your requirements.

Wide Range

Royal manufactures a wide range of Accu-Length™ Collet Chucks to fit all popular spindle noses and collet styles.

ROYAL LOW-PROFILE 5C, 16C AND 3J ACCU-LENGTH™ CNC COLLET CHUCKS



- These chucks utilize spring-type collets and therefore do not provide the parallel grip functionality or wide gripping range of our Quick-Grip™ models.
- Dead-length operation – sleeve pushes forward to compress the collet, providing precise z-axis part positioning.
- Low-profile nose offers outstanding tool clearance.
- In-stock for same-day shipping.

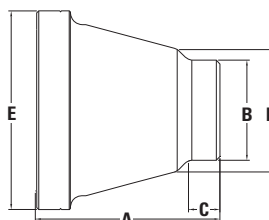

Royal Low-Profile Accu-Length™ CNC Collet Chucks

SPINDLE TYPE	COLLET TYPE	CAPACITY	A OVERALL LENGTH	B NOSE DIAMETER	C NOSE LENGTH	D BODY DIAMETER	E FLANGE DIAMETER	CHUCK WEIGHT (lbs.)	MAX DRAWBAR FORCE (lbs.)	MAX CLAMPING FORCE (lbs.)	MAX RPM	PART NUMBER	PRICE
A2-5	5C	1 ¹ / ₁₆ "	5.75	2.43	1.00	4.00	6.45	21	4,000	13,600	6,000	42330	\$6,210
A2-6	5C	1 ¹ / ₁₆ "	5.75	2.43	1.00	4.00	7.45	21	4,000	13,600	6,000	42332	6,490
110mm	5C	1 ¹ / ₁₆ "	5.55	2.43	1.00	4.00	6.45	21	4,000	13,600	6,000	42334	6,490
140mm	5C	1 ¹ / ₁₆ "	4.45	2.43	1.00	4.00	6.45	13	4,000	13,600	6,000	42336	6,490
A2-5	16C	1 ⁵ / ₁₆ "	6.50	3.25	1.03	3.80	6.45	25	5,400	18,300	6,000	42338	6,810
A2-6	16C	1 ⁵ / ₁₆ "	6.25	3.25	1.03	3.80	7.45	25	5,400	18,300	6,000	42340	7,030
A2-8	16C	1 ⁵ / ₁₆ "	7.25	3.25	1.03	3.67	9.45	51	5,400	18,300	4,500	42342	7,260
110mm	16C	1 ⁵ / ₁₆ "	6.30	3.25	1.03	3.80	6.45	25	5,400	18,300	6,000	42337	7,030
140mm	16C	1 ⁵ / ₁₆ "	6.30	3.25	1.03	3.80	6.45	25	5,400	18,300	6,000	42343	7,190
A2-5	3J	1 ³ / ₄ "	6.23	3.25	1.03	3.97	6.45	24	5,400	26,300	6,000	42344	7,030
A2-5 UC*	3J	1 ³ / ₄ "	5.47	3.25	1.03	4.06	5.20	16	5,400	26,300	6,000	42345	7,030
A2-6	3J	1 ³ / ₄ "	6.25	3.25	1.03	3.97	7.45	26	5,400	26,300	6,000	42346	7,260
A2-8	3J	1 ³ / ₄ "	7.00	3.25	1.03	3.97	9.45	49	5,400	26,300	4,500	42348	7,530
110mm UC*	3J	1 ³ / ₄ "	5.42	3.25	1.03	4.06	5.20	17	5,400	26,300	6,000	42351	7,030
140mm	3J	1 ³ / ₄ "	6.03	3.25	1.03	3.97	6.45	23	5,400	26,300	6,000	42354	7,420

*Ultra-compact length.

For capacities greater than 1.75", choose the appropriate Royal Quick-Grip™ CNC Collet Chuck from pages 12-17. Quick-Grip™ CNC Collet Chucks offer many advantages over Low-Profile Collet Chucks, including superior tool clearance, parallel-grip functionality, and better price-points.

If you would like to continue utilizing older technology S-type collet pads, you can do so with the use of our Quick-Grip™ master collets – see page 44 for additional information.



ROYAL LOW-PROFILE 5C, 16C & 3J PULLBACK CNC COLLET CHUCKS

Simple Design

Royal Low-Profile Pullback CNC Collet Chucks provide a simple, low-cost method for utilizing collets on all CNC lathes and turning centers.

Spindle Bearing Protection

An oversized flange acts as a coolant slinger to protect lathe spindle bearings from contaminants. An internal O-ring protects sliding components from coolant and fines.

High RPM

All Royal CNC Collet chucks are balanced by design for high-speed operation, and can often be **run at higher speeds than conventional 3-jaw chucks** because they are less prone to the negative effects of centrifugal force.



Proudly
Made
in U.S.A.

Wide Range

Royal manufactures a wide range of chucks to fit all popular spindle noses and collet styles. Gripping capacities range from 1/64" to 1-3/4" diameter.

High Accuracy

All Royal Low-Profile Pullback CNC Collet Chucks are guaranteed to run within 0.0002" TIR.

Adjustability

Dual collet retaining screws ensure **easy collet installation** and adjustability.

Low-Profile

All external dimensions have been optimized to provide outstanding tool clearance and rigidity.

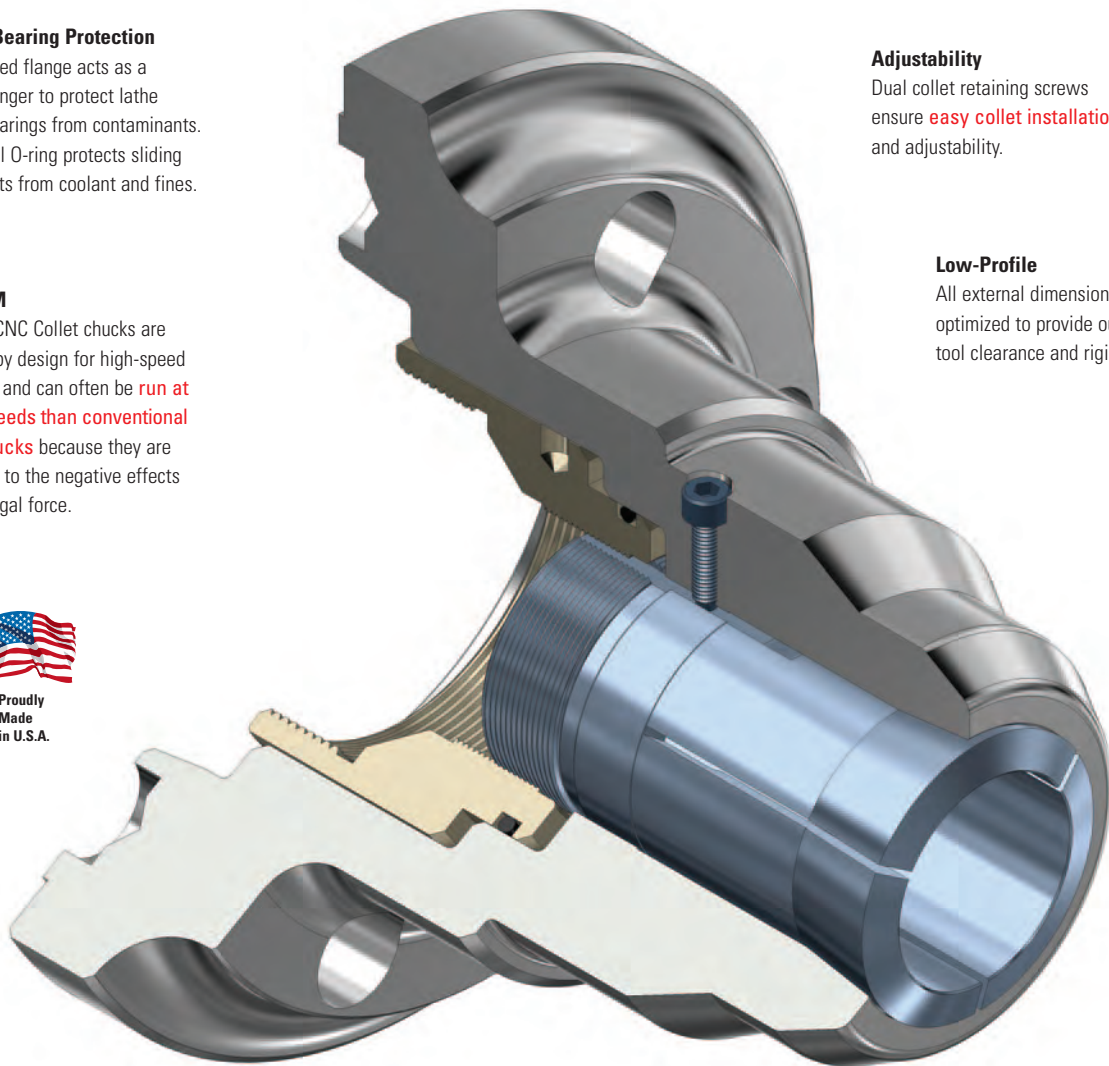

Easy Installation

All Royal Low-Profile Pullback Chucks include a collet wrench, mounting hardware, mounting wrenches, and a custom-machined drawtube connector to ensure hassle-free installation.

Heavy-Duty Construction

All chuck components, except for the drawtube connector, are hardened to Rc 61-63 for rigidity and durability.

Specials

If you have a special application that goes beyond the scope of our standard line, we will be happy to design and build a custom system to meet your needs. Please contact a Royal applications engineer to discuss your requirements.

ROYAL LOW-PROFILE 5C, 16C & 3J PULLBACK CNC COLLET CHUCKS



- Traditional pullback design – collet is drawn into chuck for closing, pushed out for opening.
- Typically used on first-operations where holding precise axial positioning is not required.
- In-stock for same-day shipping.

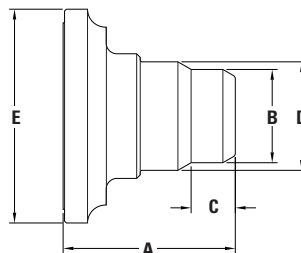

Royal Low-Profile Pullback CNC Collet Chucks

SPINDLE TYPE	COLLET TYPE	CAPACITY	THREADED NOSE*	A OVERALL LENGTH	B NOSE DIAMETER	C NOSE LENGTH	D BODY DIAMETER	E FLANGE DIAMETER	CHUCK WEIGHT (lbs.)	MAX DRAWBAR FORCE (lbs.)	MAX CLAMPING FORCE (lbs.)	MAX RPM	PART NUMBER	PRICE
A2-5	5C	1 1/16"	N	5.00	2.63	1.05	3.14	6.45	12	4,490	15,750	6,000	42053	\$1,880
A2-5	5C	1 1/16"	Y*	5.00	2.187-10	1.22	3.14	6.45	11	4,490*	15,750	6,000*	42054	2,090
A2-6	5C	1 1/16"	N	5.00	2.63	1.05	3.14	7.45	17	4,490	15,750	6,000	42055	2,220
A2-6	5C	1 1/16"	Y*	5.00	2.187-10	1.22	3.14	7.45	15	4,490*	15,750	6,000*	42080	2,410
A2-6	5C	1 1/16"	N	6.00	2.63	1.05	3.14	7.45	19	4,490	15,750	6,000	42057	2,480
A2-6	5C	1 1/16"	Y*	6.00	2.187-10	1.22	3.14	7.45	18	4,490*	15,750	6,000*	42058	2,650
A2-8	5C	1 1/16"	N	6.00	2.63	1.05	3.14	9.45	30	4,490	15,750	4,500	42059	2,850
A2-5	16C	1 5/8"	N	6.00	3.00	1.85	3.31	6.45	13	5,390	19,800	6,000	42067	2,410
A2-6	16C	1 5/8"	N	6.00	3.25	1.54	3.78	7.45	20	5,390	19,800	6,000	42069	2,590
A2-8	16C	1 5/8"	N	6.00	3.25	1.54	3.78	9.45	30	5,390	19,800	4,500	42071	2,830
A2-5	3J	1 3/4"	N	6.00	3.08	1.16	3.33	6.45	13	5,390	26,340	6,000	42061	2,510
A2-6	3J	1 3/4"	N	6.00	3.25	1.05	3.87	7.45	20	5,390	26,340	6,000	42063	2,720
A2-8	3J	1 3/4"	N	6.00	3.25	1.05	3.87	9.45	31	5,390	26,340	4,500	42065	3,340

*Threaded-nose collet chucks are for use with 5C step collets that close on the head, not the 10-degree angle. Never exceed the manufacturer's rpm and drawbar force limits for any threaded accessories.

For capacities greater than 1.75", choose the appropriate Royal Quick-Grip™ CNC Collet Chuck from pages 12-17. Quick-Grip™ CNC Collet Chucks offer many advantages over Low-Profile Collet Chucks, including superior tool clearance, parallel-grip functionality, and better price-points.

If you would like to continue utilizing older technology S-type collet pads, you can do so with the use of our Quick-Grip™ master collets – see page 44 for additional information.



ROYAL LOW-PROFILE 5C, 16C & 3J COLLET CHUCK ACCESSORIES

Ejectors



- Ejectors are used in sub-spindle applications to push finished workpieces into the part catcher upon completion.
- Spring is encased inside of body for protection.
- A hardened plunger rod and a bronze bearing work together to provide **smooth, consistent operation.**

Royal Ejectors for Low-Profile Collet Chucks

FITS CHUCK MODEL	PART NUMBER	PRICE
5C Accu-Length™	45145	\$718
16C Accu-Length™	45146	793
3J Accu-Length™	45147	793

For an alternative solution to an ejector, check out the Royal Grippex Coolant-Actuated Bar Puller. The Grippex, when fitted with special robot gripper jaws, can be used to pull finished parts from a sub-spindle, eliminating the need for an ejector and **freeing up the spindle bore to swallow longer parts.**

Collet Stops



- A collet stop is used for **accurate z-axis positioning** of short workpieces within a collet.
- Stop rod length is easily adjusted.
- Assembly screws directly into rear of collet.

Royal Collet Stops for Low-Profile Collet Chucks

FITS CHUCK MODEL	PART NUMBER	PRICE
5C Accu-Length™ and Pullback	20030	\$32
16C Accu-Length™ and Pullback	45151	316
3J Accu-Length™ and Pullback	45152	316

Heavy-Duty Collet Wrenches



- Heavy-duty one-piece head – pins won't shear off.
- Comfortable knurled handle offers superior grip and makes collet installation a breeze.
- Cross-drilled hole in handle allows a screwdriver to be used as a lever for hard-to-remove collets.

Royal Heavy-Duty Collet Wrenches

COLLET STYLE	NUMBER OF COLLET SLOTS	PART NUMBER	PRICE
5C	3	45187	\$180
16C/3J	3	45188	180
16C/3J	4	45189	180

ROYAL 5C, 16C, & 3J KEY-OPERATED COLLET FIXTURES



- ❑ Opened and closed via an internal cam mechanism.
- ❑ Accu-Length™ operation – collet and workpiece position remains fixed for precise length control.
- ❑ Can be used in both **stationary and rotary table applications.**
Caution – not for use on lathes or grinders above 5 rpm!
- ❑ Special model 62004 bolts directly to Haas HRT-100 and HRT-110* and other small indexers.
Note – cam bolt is recessed on this model.
- ❑ All other models configured for both four and six-slot mounting – 4.125" bolt circle diameter.
- ❑ All models include cam wrench.

Type 1

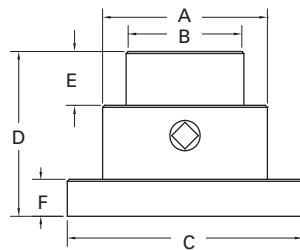

Type 2

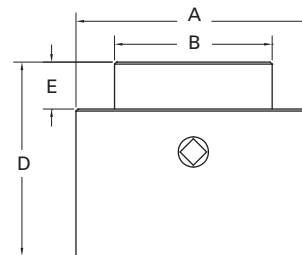

Royal 5C, 16C and 3J Key-Operated Collet Fixtures

MODEL	CAPACITY	TYPE	A	B	C	D	E	F	PART NUMBER	PRICE
5C	1 ¹ / ₁₆ "	Type 1	3.37	2.50	4.95	3.50	1.15	0.75	62002	\$1,120
5C (for HRT-100 & 110)*	1 ¹ / ₁₆ "	Type 2	4.20	2.50	-	3.50	1.15	-	62004	1,170
16C	1 ⁵ / ₈ "	Type 2	4.95	3.35	-	4.63	1.50	-	62006	1,690
3J	1 ³ / ₄ "	Type 2	4.95	3.35	-	4.13	1.00	-	62008	1,690

*Haas, HRT-100 and HRT-110 are registered trademarks of Haas Automation, Inc.



ROYAL 5C EXPANDING COLLETS

- Unlike chucks and most collets that grip the OD of a workpiece, 5C expanding collets are designed to grip on the ID of a part.
- Accu-length design ensures **precise workpiece positioning** – no z-axis movement.
- Collet head is easily machined to required size. Can be re-machined as necessary.
- Concentricities of ± 0.0002 " can typically be achieved using Royal 5C expanding collets.
- Made from 1144 steel that can be hardened after machining for wear resistance.



Head is easily machined to required size by customer. See chart for range.

Precision ground body for excellent workpiece concentricity.

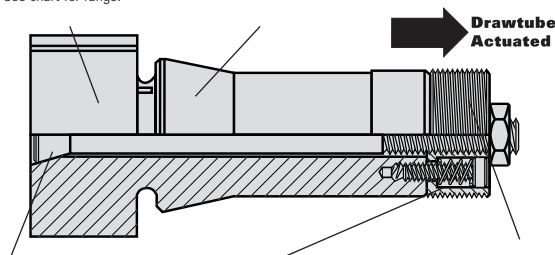

Expanding rod is hardened and ground for strength and durability.

Internal spring provides positive release.

Rear threaded section is separate from collet body. When this section is pulled back by the drawtube, it pulls the tapered expanding rod back, causing the head to expand.

Royal 5C Internal Expanding Collets

NOMINAL HEAD DIAMETER	HEAD LENGTH	MACHINABLE RANGE MIN-MAX	PART NUMBER	PRICE
3/4"	1"	1/4"–1 1/16"	20100	\$259
1"	1"	7/16"–1 5/16"	20101	259
1 1/2"	1"	3/4"–1 7/16"	20102	246
1 1/2"	1 1/2"	3/4"–1 7/16"	20103	270
1 1/2"	2"	3/4"–1 7/16"	20104	271
2"	1"	3/4"–1 15/16"	20107	284
2"	1 1/2"	3/4"–1 15/16"	20108	299
2"	2"	3/4"–1 15/16"	20109	344
2 1/2"	1"	3/4"–2 7/16"	20112	347
3"	1"	3/4"–2 15/16"	20117	381
5"	2"	3/4"–4 15/16"	20127	732

Replacement Expanding Rods

HEAD DIA.	HEAD LENGTH	PART NUMBER	PRICE
3/4"	1"	20135	\$76
1"	1"	20136	70
1 1/2"–5"	1"	20130	53
1 1/2"–5"	1 1/2"	20131	57
1 1/2"–5"	2"	20132	58



ROYAL 5C STEP COLLETS



- Royal step collets allow large diameter parts to be held in a 5C collet.
- Head can be easily bored out by customer to required size.
- Three dowel pins are supplied to **ensure accurate machining**.
- 1/4" thick head allows for 1" bore depth.
- Collets are made from 1144 steel and can be hardened for wear resistance.

Royal 5C Step Collets

HEAD DIA.*	PILOT HOLE	PIN DIA.	PART NUMBER	PRICE
2"	1/4"	1/8"	20020	\$234
3"	5/16"	1/4"	20022	310
4"	5/16"	1/4"	20024	482
5"	5/16"	1/4"	20025	624

*We recommend ordering a collet with a head diameter at least 1/2" larger than workpiece diameter.

Note — these step collets close on the 10° angle, not the head OD. When using, be sure part is sufficiently clamped.