

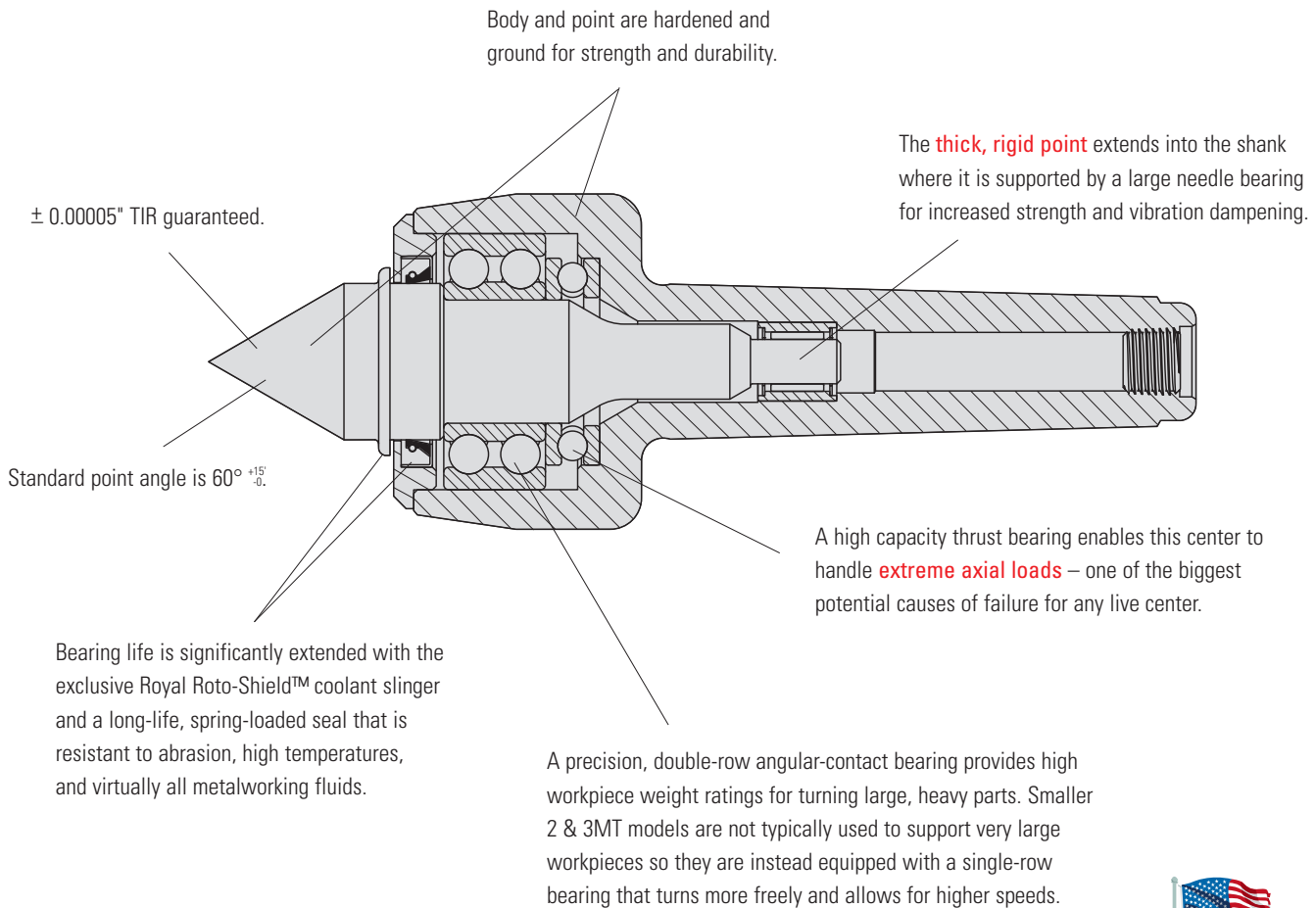

# ROYAL HEAVY-DUTY SPINDLE TYPE LIVE CENTERS



- ❑ One of our most popular models – an excellent **heavy-duty live center** designed to handle almost all CNC and manual turning jobs.
- ❑ Heavy-duty precision bearings provide exceptional radial and thrust load capacities.
- ❑ The thick, rigid point extends into the shank where it is supported by a large needle bearing for increased strength and vibration dampening.
- ❑ Exclusive Roto-Shield™ coolant slinger and upgraded seal provide outstanding bearing protection for extended operating life.
- ❑ Body and point are hardened and ground for accuracy and durability.

# ROYAL HEAVY-DUTY SPINDLE TYPE LIVE CENTERS



**EXCLUSIVE ROYAL  
ROTO-SHIELD™  
TECHNOLOGY**



**✓ High-Pressure  
Coolant Approved**

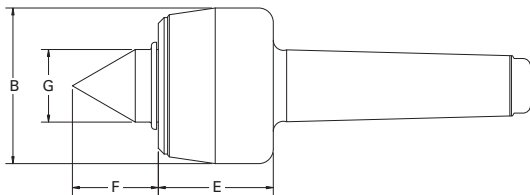

## Royal Heavy-Duty Spindle Type Live Centers

TAPER	B	E	F	G	MAX. SUGGESTED RPM*	WEIGHT OF WORKPIECE (lbs.)	THRUST LOAD (lbs.)	PART NUMBER	PRICE
2 MT	1.75	1.47	1.01	0.88	6,000	725	2,360	10102	<b>\$660</b>
3 MT	2.33	1.75	1.22	1.00	5,000	970	3,900	10103	<b>660</b>
4 MT	2.68	1.98	1.48	1.25	4,500	1,720	4,050	10104	<b>860</b>
5 MT	3.45	2.81	1.84	1.50	3,500	3,260	5,700	10105	<b>1,185</b>
6 MT	4.00	3.15	2.31	2.00	3,500	4,080	6,000	10106	<b>2,217</b>

\* Maximum recommended operating limit. Operating above this speed could result in heat build-up and accelerated bearing wear.

**Insist on Roto-Shield™ Technology – Only Available on Royal Live Centers**