

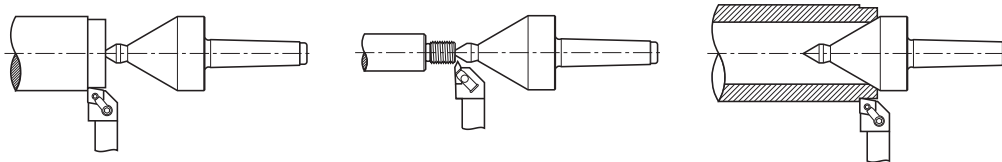

ROYAL VERSA-TURN LIVE CENTERS

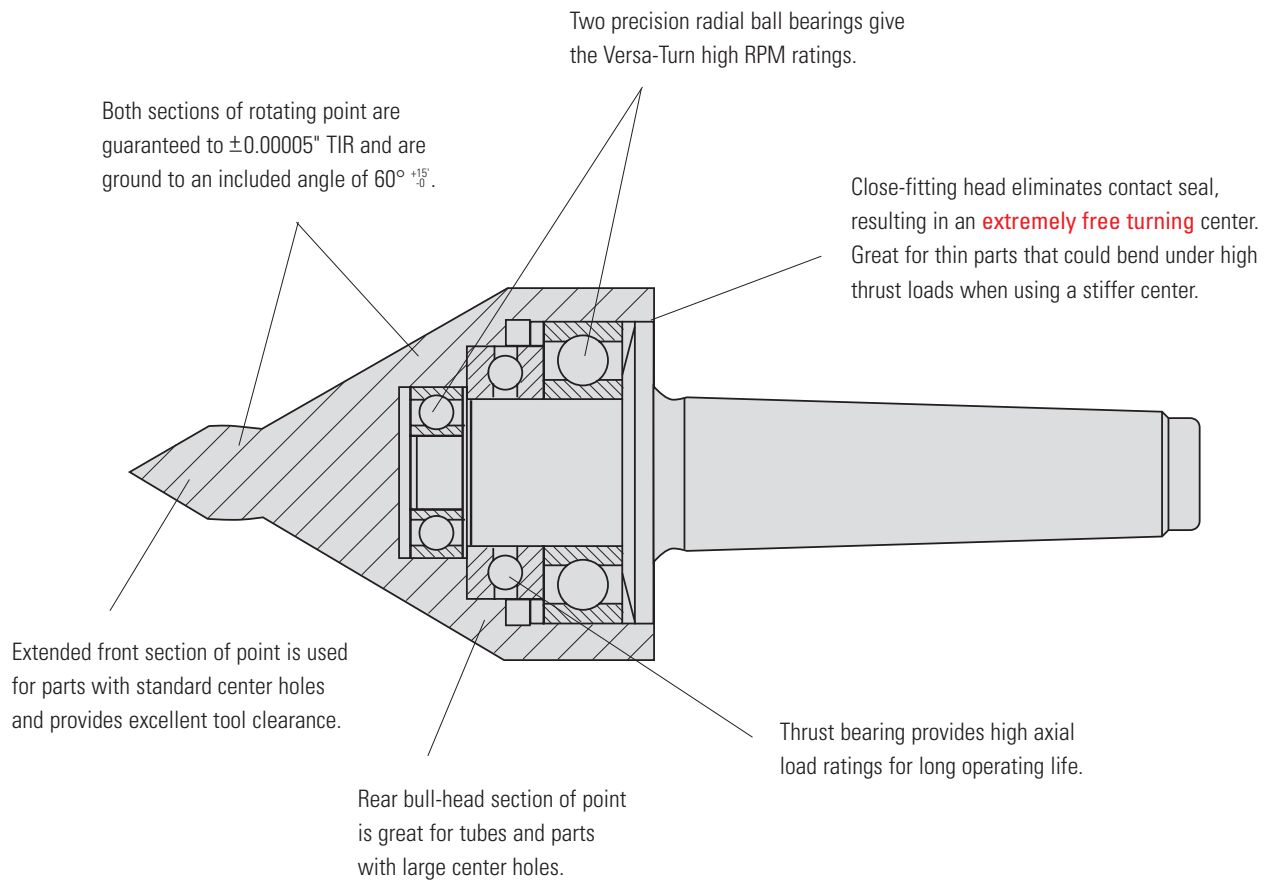

- ❑ An excellent **multi-purpose live center** designed to handle most common turning jobs.
- ❑ The Royal Versa-Turn™ is extremely free turning, making it an **ideal choice for thin parts** that could bend when subjected to high thrust loads.
- ❑ The unique design is really two centers in one, providing great value for cost-conscious manufacturers.



ROYAL VERSA-TURN LIVE CENTERS

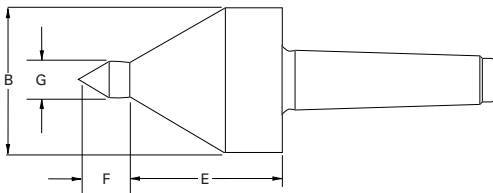
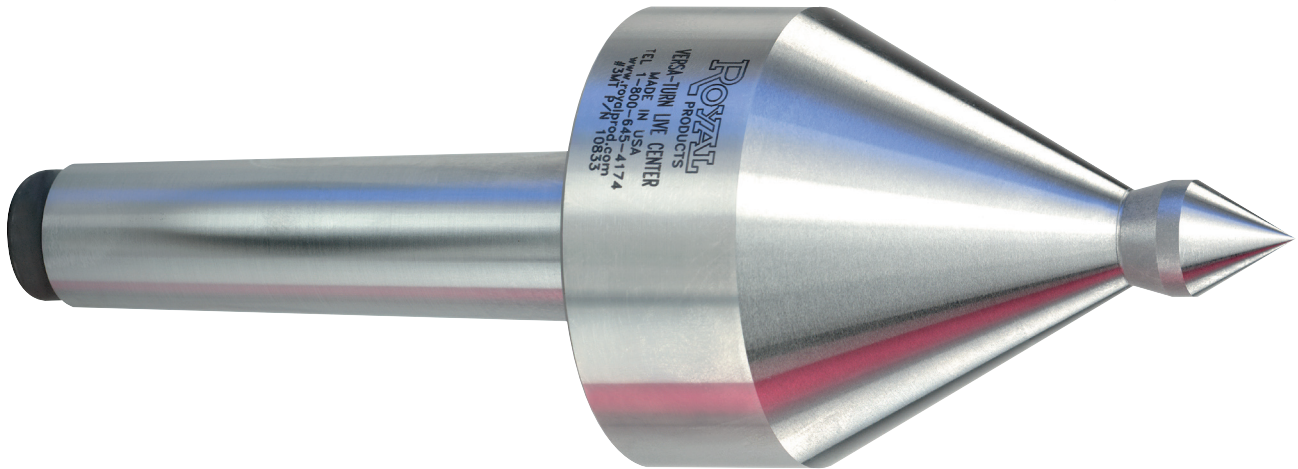

**Extremely Free Turning –
Great for Thin Parts**

Royal Versa-Turn Live Centers

TAPER	B	E	F	G	MAX. SUGGESTED RPM*	WEIGHT OF WORKPIECE (lbs.)	THRUST LOAD (lbs.)	PART NUMBER	PRICE
3 MT	2.13	2.22	0.74	0.50	5,000	330	2,160	10832	\$543
3 MT HD	2.50	2.60	0.93	0.63	4,000	685	5,000	10833	613
4 MT	2.50	2.60	0.93	0.63	4,000	685	5,000	10834	630
4 MT HD	3.38	3.15	1.12	0.75	3,500	1,165	5,700	10835	856
5 MT	3.38	3.15	1.12	0.75	3,500	1,165	5,700	10836	901

* Maximum recommended operating limit. Operating above this speed could result in heat build-up and accelerated bearing wear.