



ROYAL FILTERMIST MODEL FX-300



- ❑ Used primarily on small, enclosed CNC machines with an internal volume of up to 80 cu. ft.
- ❑ Large 6" dia. intake results in a **very low intake velocity**, reducing the likelihood that chips and large droplets will be drawn into the unit.
- ❑ The model FX-300 comes complete with a collar seal, mounting hardware, and 5 ft. of coolant return hose.
- ❑ Designed primarily for direct-mounting to the top of a machine, but stands and brackets are also available for applications where direct-mounting is not possible.
- ❑ Stainless steel model (type 304) available for special applications such as food processing and aqueous parts washers.
- ❑ **A great option for Swiss machines** when used in conjunction with our high-performance after filter.

FX-300 Specifications

Airflow	295 cfm
Fits machines with enclosure volume of:	Up to 80 cubic feet
Motor	3/4 HP (0.55 kW), 3-Phase, 50/60 Hz. Voltage & Current @ 60Hz: 208V - 2.6A 230V - 2.6A 460V - 1.4A
Weight	31 lbs.
Noise Level	65 dBA
Inlet Diameter	6"

Mounting Options — FX-300

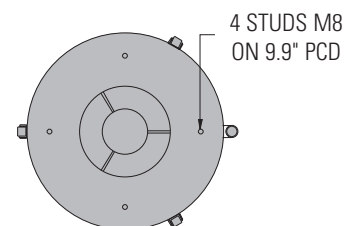
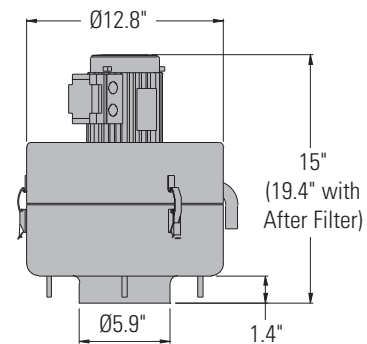

Mounting Option	Hardware included with Filtermist Unit
Direct Mount	Hardware included with Filtermist Unit
Floor Stand	use 30316 — Floor Stand "A"
Machine Top Stand	use 30319 — Machine Top Stand "A"
Wall Mount	use 30328 — Wall Bracket "A"
Machine Side Mount	use 30330 — Side-Mount Bracket "A"



ROYAL FILTERMIST MODEL FX-300





Filtermist Units

DESCRIPTION	PART NUMBER	PRICE
 FX-300 Filtermist Unit Includes collar seal and all necessary hardware to mount unit directly to the top of a machine. Also includes 5 ft. of coolant return hose.	30105 <i>See Promo on Page 147</i>	\$2,395
 FX-300 Stainless Steel Unit	30165	\$4,655

Electrical Accessories

DESCRIPTION	PART NUMBER	PRICE
 Starter Box Kit Includes NEMA 12 box, IEC motor starter, 20 ft. of input cable, 15 ft. of output cable with turn-lock connector	FX-300 & 575 Low-Voltage (208/230V)	30470 \$585
	FX-300 & 575 High-Voltage (460V)	30471 \$585

Performance Accessories

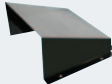
DESCRIPTION	PART NUMBER	PRICE
 Standard After Filter "A" Used for collecting dry smoke and very fine mist particles.	30200 <i>See Promo on Page 147</i>	\$275
 High-Performance After Filter "A" Designed for high pressure and Swiss applications. Extended operating life over standard after filter.	30203	\$739
 Chip Deflector "A" Protects intake from coolant splash and chips.	30222	\$75
 Maintenance Monitor Bright LED status indicator monitors performance and shows when maintenance is required.	30477	\$640

Mounting Accessories

DESCRIPTION	PART NUMBER	PRICE	
 Side Mounting Bracket "A" Allows unit to be mounted to the side of a machine tool. Includes hardware and chip deflector.	30330	\$375	
 Floor Stand "A" Fixed height of 6 ft. Bolts to floor for safety.	30316	\$610	
 Machine Top Stand "A" 28" tall stand bolts to the top of a machine	30319	\$385	
 Wall Bracket "A" For mounting unit to a wall or side of a machine.	30328	\$205	
 Coolant Return Hose 3/4" diameter. Note: Also included with unit. See description.	30335	\$4/ft.	
 Ducting Flexible vinyl with heavy wire support.	8"	30344 \$22/ft.	
	6"	30342 16/ft.	
	4"	30340 12/ft.	
Warning — never use sheetmetal ducting or any other type that could leak and cause a hazardous condition.			
 Ducting Clamps For securing ducting to accessories	8"	30354 \$7	
	6"	30352 6	
	4"	30350 6	
 Y-Junctions For multiple pickup locations.	A 8"	B 6"	30368 \$370
	8"	4"	30366 460
	6"	6"	30364 340
	6"	4"	30362 320
	4"	4"	30360 265
 Flange Adapters For securing ducting directly to an enclosed machine.	8"	30374 \$80	
	6"	30372 75	
	4"	30370 75	
 Reducers	A 8"	B 6"	30382 \$145
	6"	4"	30380 145
	A 8"	B 11.75" x 5"	30394 \$260
 Fishtails For use on open machines.	6"	10" x 4.5"	30392 240
	4"	8.25" x 3.5"	30390 220



Try a unit on your toughest application risk-free! See Page 147.