

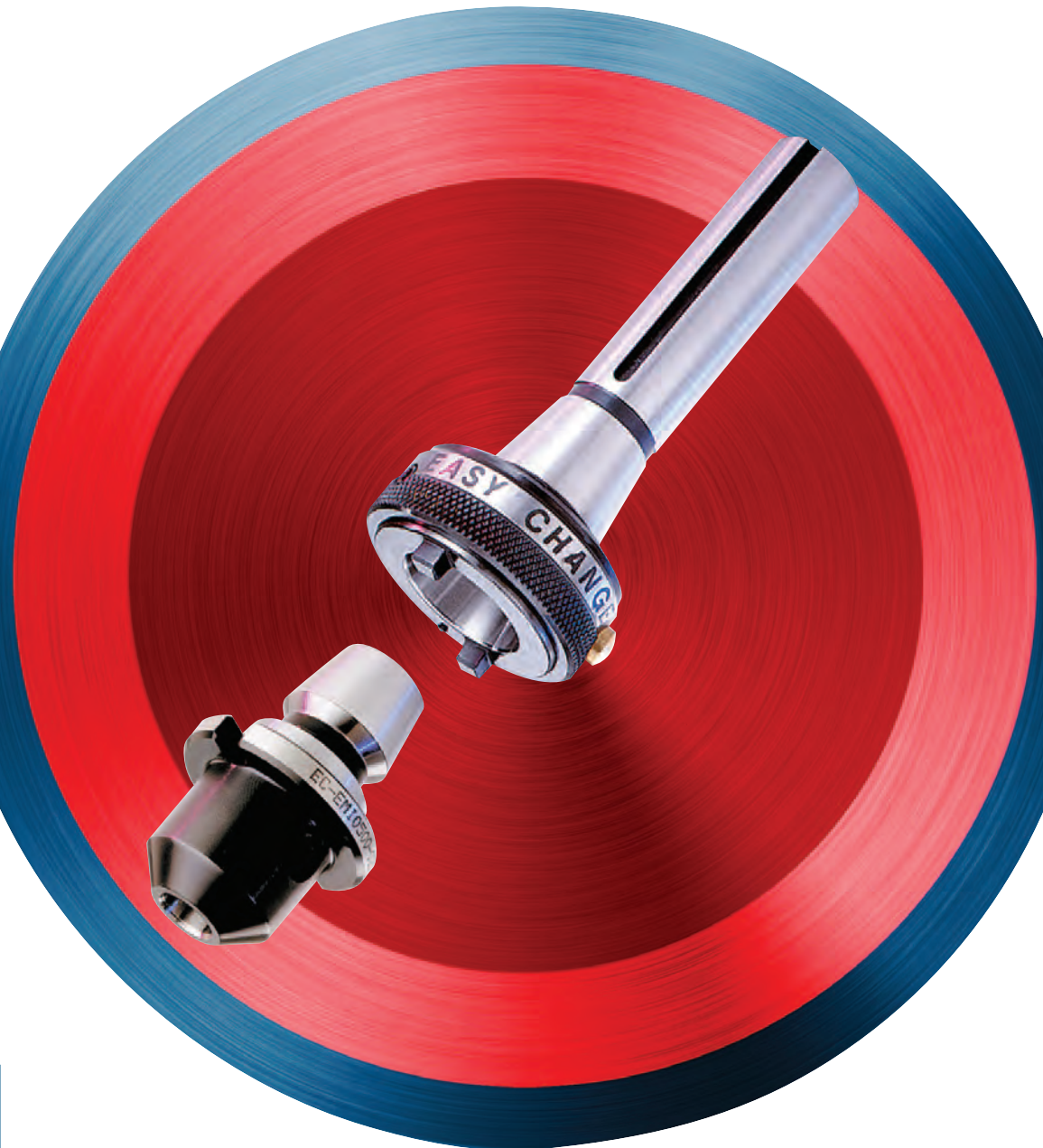

MACHINE SHOP ACCESSORIES

CLEVER, TIME-SAVING PRODUCTS
TO MAKE YOUR LIFE EASIER





ROYAL R8 QUICK-CHANGE TOOLING SYSTEM



1. Loading the Quick-Change Body into a standard R8 spindle.



2. Loading drill chuck holder and drill into body.



3. Removing drill chuck holder with one hand.



4. Inserting endmill holder and endmill for next operation.

- ❑ The Royal Quick-Change Tool System provides a **fast method for changing tools** on a Bridgeport-style mill – once the R8 body is installed in the machine spindle, tools can be changed in seconds.
- ❑ One hand operation – simply depress the brass locking button and rotate collar to the locked-open position. When a new tool is inserted, it depresses a spring-loaded pin, snapping the collar back into the locked-closed position.
- ❑ Very accurate – total system runout can be less than 0.0005" TIR under the right circumstances.
- ❑ **Short overhang (1 1/8")** and two positive-drive keys enable many common milling and drilling operations to be easily performed.

Please note that this tool is designed for light/medium-duty applications where the ability to change tools quickly outweighs the need for extreme rigidity. We do not recommend using this system for heavy milling or high-production applications.

ROYAL R8 QUICK-CHANGE TOOLING SYSTEM



R8 Quick-Change Body Only

– Only protrudes 1/8" from gage line.

PART NUMBER	PRICE
24100	\$1,270



Start-Up Milling Kit

Consisting of:

- Quick-Change Body
- One 3/8" Endmill Tool Holder
- One 1/2" Endmill Tool Holder
- One 5/8" Endmill Tool Holder
- One Stand FREE

PART NUMBER	PRICE
24330	\$2,455



Start-Up Drill & Mill Kit

Consisting of:

- Quick-Change Body
- Three Drill Chuck Tool Holders (specify tapers)
- One 3/8" Endmill Tool Holder
- One 1/2" Endmill Tool Holder
- One 5/8" Endmill Tool Holder
- One Stand FREE

PART NUMBER	PRICE
24335	\$3,440



Endmill Tool Holder*

BORE SIZE	D	L	PART NUMBER	PRICE
1/8"	1/2"	1 3/8"	24200	\$396
3/16"	11/16"	1 3/8"	24205	396
1/4"	11/16"	1 3/8"	24210	396
3/8"	1 3/16"	1 3/8"	24215	396
1/2"	1 3/8"	1 3/8"	24220	396
5/8"	1 9/16"	1 5/8"	24225**	396
3/4"	1 13/16"	2 3/16"	24230**	419
1"	2"	2 15/16"	24235**	467

* Single endmills only. Designed for minimum overhang.

** For light milling only. For heavy milling use solid endmill holder.



Collet Chuck Tool Holder

FOR ERICKSON™ COLLET MODEL	MAX. COLLET CAPACITY	A	PART NUMBER	PRICE
200 DA	3/8"	1 9/16"	24260	\$565
180 DA	3/4"	1 13/16"	24265	596
ER -16*	3/8"	1 9/16"	24266	583
ER -32*	3/4"	1 15/16"	24268	626

* Collets available on pages 144 – 145.



Drill Chuck Tool Holder

JACOBS TAPER	L*	PART NUMBER	PRICE
J2	1 3/32"	24285	\$334
J3	1 3/32"	24290	334
J6	1 3/32"	24295	334
J33	1 3/32"	24300	334

* Gage line to gage line distance.

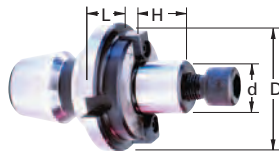

Shell Mill Tool Holder

"d" SIZE	D	L	H	PART NUMBER	PRICE
1/2"	1 1/4"	9/16"	1 9/32"	24250	\$516
3/4"	1 11/16"	9/16"	2 3/32"	24255	565



Tool Holder Stand

PART NUMBER	PRICE
24325	\$153



ROYAL MACHINE MOUNTS



- Royal machine mounts are built tough to level and last. All metal parts are zinc plated for rust protection and long life.
- Royal machine mounts simplify machine installation, reduce noise, and isolate vibration.
- Great for injection molding machines, presses, lathes, mills, and grinders.
- These mounts **meet OSHA requirements** by preventing machines from “walking” without the need for bolting or cementing.
- All Royal machine mounts incorporate a large, chloroprene rubber base that is resistant to oil, water, and many chemicals.
- Support cup is machined from a solid bar instead of deep drawn, resulting in increased thickness for strength and rigidity.
- Unique internal retaining clip ensures that mounts will stay together if machine is moved to a new location.
- Royal machine mounts **protect sensitive machine components**, improve performance, and reduce maintenance costs.

Royal Machine Mounts are Built Tough to Level and Last!

Shock plate (models #4 and #5 only) increases both the vertical and horizontal load carrying capacities, making these an excellent choice for impact-type machinery such as presses and injection molding machines.

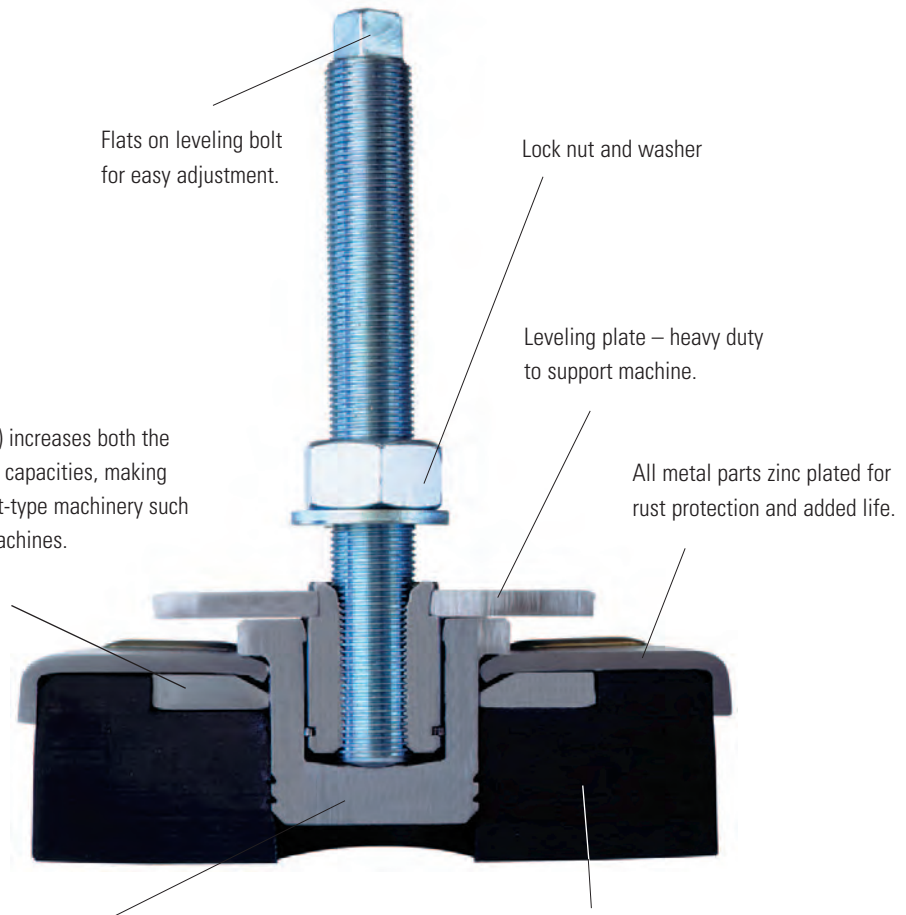

Heavy-duty support cup is machined from a solid steel bar for strength. Other brands rely on a thin drawn cup which often fails by fatigue. Note the increased thickness of the lip and bottom sections.

Thick chloroprene base is resistant to most chemicals.

IMPORTANT – Before installing mounts on any machine, make sure they are approved for use by the machine manufacturer.

ROYAL MACHINE MOUNTS



Choosing the Correct Royal Machine Mounts

1. Calculate the load on each mount by dividing the total weight of the machine by the number of mounting locations.

Note: sometimes it may be necessary to compensate for machines that do not have an evenly distributed load.

2. Find the category in the specification chart which corresponds to the type of machine being installed.

3. Match up the correct mount with the machine.

Example: Suppose you wish to mount an 18,000-lb. CNC lathe which has six mounting locations.

$$18,000/6=3,000 \text{ lbs. per mount}$$

From the chart on the next page we see that this machine falls into the range of the #3 mount for non-impact machinery.

Warning: Always use the correct mount for each machine. These mounts are not designed for machines that must be bolted to the floor to prevent tipping. If you have any questions, please contact one of our application engineers at 1-800-645-4174.

Royal Machine Mounts

		#1	#2	#3	#4	#5
Load Range per Mount (lbs.)	General Non-Impact Machinery	100–1,100	880–2,200	1,760–5,500	3,300–8,800	6,600–12,000
	Injection Molding Machines	390 max.	790 max.	2,180 max.	5,450 max.	8,220 max.
	up to 125 strokes / min	150–440	440–880	880–3,080	3,080–5,940	5,940–8,800
	Presses up to 180 strokes / min	130–300	300–770	770–2,420	2,420–4,290	4,290–7,700
	up to 200 strokes / min	110–260	260–550	550–1,760	1,760–2,860	2,860–5,280
Mount Dimensions	Base Diameter	3.16	4.75	6.31	6.31	7.88
	Leveling Plate Diameter	2.38	3.12	3.93	3.93	3.93
	Height to Top of Leveling Plate	1.63	1.94	2.31	2.31	2.72
	Height to Top of Bolt	5.25	5.25	7.50	7.50	7.88
	Leveling Bolt Size	M12 x 1.25	M16 x 1.5	M20 x 1.5	M20 x 1.5	M20 x 1.5
	Standard Leveling Bolt	4.72	4.72	6.88	6.88	6.88
	Level Adjustment	0.88	0.88	1.00	1.00	1.00
Ordering Info	Part Number	27001	27002	27003	27004	27005
	Price Each	\$57	\$110	\$158	\$189	\$308

Extra-Long Leveling Bolts

For machines with thick bases.

MOUNT TYPE	BOLT SIZE	BOLT LENGTH	PART NUMBER	PRICE
#1	M12 x 1.25	8¼"	27007	\$28
#2	M16 x 1.5	8¼"	27008	33
#3–#5	M20 x 1.5	9¾"	27009	46

**Easy Installation —
No drilling or bolting
to floor required**

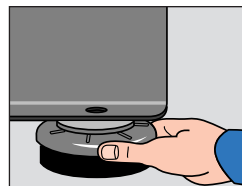

Raise machine and slide mount into place.

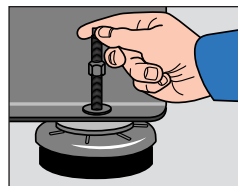

Insert leveling bolt through machine base hole and thread into mount. Lower machine onto leveling plate.

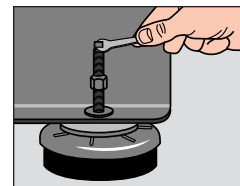

Raise or lower machine by turning leveling bolt.

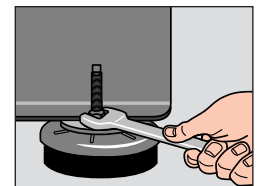

When machine is level, secure in place with washer and lock nut.



ROYAL PNEUVAC™ PUMP

The Royal PneuVac pump is a simple device that uses a compressed air-powered venturi to create a vacuum. All you have to do to operate the unit is: attach the pump and hose to a standard 55-gallon drum, hook up your compressed air supply to the pump, insert the free end of the suction hose into the sump or storage tank, and open the air valve. The coolant and sludge is drawn through the hose and deposited into the drum — quick, clean, and hassle free!



Clean Your Coolant Sumps in Less Than Two Minutes

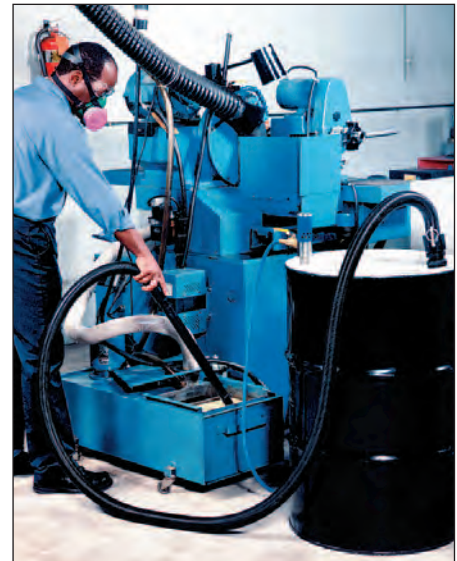

The Royal PneuVac pump filled this 55-gallon drum with coolant in less than two minutes.

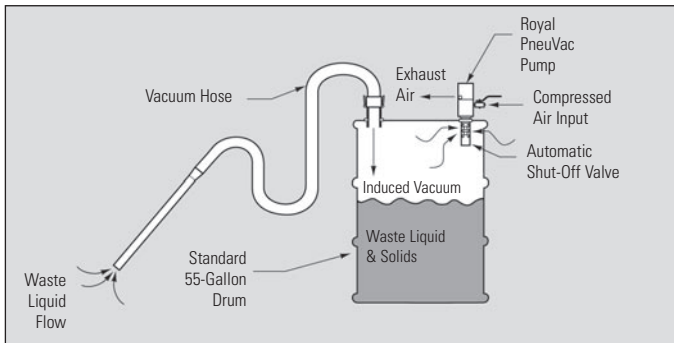

Heavy Duty Construction – Entire pump (except ball valve, float and O-ring) is made from either stainless steel or aluminum. Other brands are made from rust-prone carbon steels and light-duty plastics.

Very Safe – The PneuVac pump is powered by compressed air. This eliminates the possibility of electric shocks often associated with motor-driven pumps. An automatic shut-off valve activates when the drum is full.

Fast – The Royal PneuVac pump can fill a 55-gallon drum in just 90 seconds. Conventional electric pumps can take up to one hour to move the same amount of liquid.

Thorough – This pump not only removes liquid but will also pick up sludge, metal chips and other debris which often clog or wear out impeller-type pumps.

Quiet – Unique baffle system limits noise level without compromising performance.

Low Maintenance – The PneuVac pump requires very little maintenance because only compressed air flows through the pump body itself.

Great Warranty – Royal Products provides a 3-year warranty against failure of this product due to manufacturing defects.

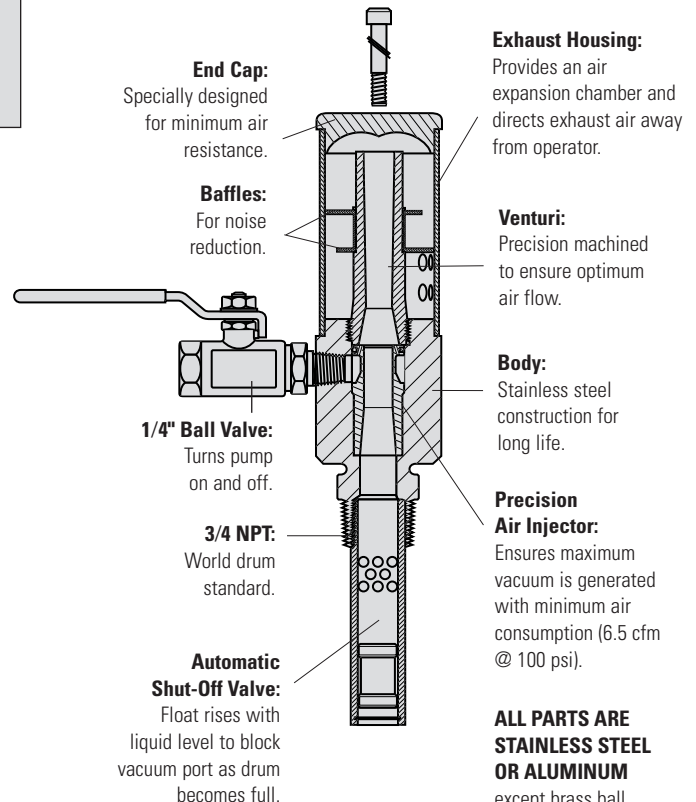

ALL PARTS ARE STAINLESS STEEL OR ALUMINUM except brass ball valve, Delrin float and Buna-N O-ring.

ROYAL PNEUVAC™ PUMP



Royal PneuVac Pump Kit

Consists of pump, 1/4" ball valve, automatic shut-off valve, 10 ft. of smooth-bore hose, quick-disconnect drum fittings, and one 18" aluminum wand.

DESCRIPTION	PART NUMBER	PRICE
Stainless Steel Pump Kit	48010	\$1,370
Aluminum Pump Kit	48017	1,165
10ft. Replacement Hose w/Cuff (1½" Dia.)	48019	122

CAUTION:

1. Do not use the PneuVac pump with flammable or volatile liquids such as gasoline, alcohol, kerosene, aviation fuel, mineral spirits or any similar liquid with a low flash point.
2. Do not modify this product to pressurize drum to pump liquids out. Pressurizing drum could cause an explosion that might result in a serious injury.

ROYAL PNEUVAC™ AIR GUNS



- The Royal PneuVac gun makes shop blow-off and cleanup tasks a breeze.
- Unique design enables unit to act as both a blow gun and a vacuum.
- The deep hole gun is a modified version of the PneuVac gun, designed for removing chips from blind holes. The thin black tube blasts high pressure air to dislodge chips while the main nozzle draws them safely away. A clear plastic shroud protects the operator from flying debris.
- High-output venturi design multiplies air flow. For example, an input air supply of 10 cfm results in an output of approximately 100 cfm.
- Changing between **blow and vacuum modes** is accomplished by simply reversing the direction of the venturi.
- Full-length trigger design reduces strain.
- High vacuum production with minimal air consumption.
- Made of rugged, anti-static nylon.

Standard PneuVac Gun



PneuVac Deep Hole Gun



DESCRIPTION	PART NUMBER	PRICE
PneuVac Gun Only	49005	\$160
Dust Bag Kit (PneuVac Gun, Dust Bag, and Clamp)	49085	216
Hose Kit (PneuVac Gun, 10ft. Smooth-Bore Hose, and Clamp)	49080	241
Deep Hole Gun Only	49010	219
Dust Bag and Clamp Only	49020	65
10ft. Smooth Bore Hose Only (1¼" Dia.)	49090	83

Caution: Always wear safety glasses when operating these tools. Never operate in the vacuum mode unless a hose or dust bag is attached to the exhaust end of the unit.



ROYAL CHUCK STOPS

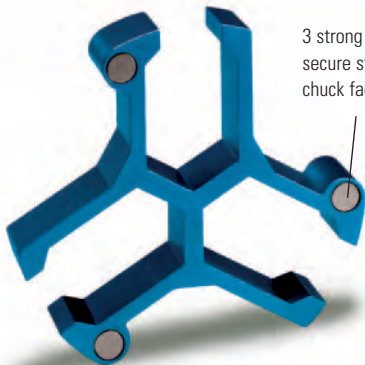

3 strong magnets secure stop to chuck face.

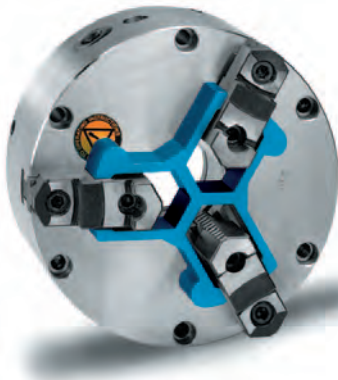

- The Royal Chuck Stop provides a simple, consistent method for **locating short parts** in a 3-jaw lathe chuck.
- Captive, web-shaped design eliminates the danger of using spacers or parallels that could come loose and be thrown from a spinning chuck. Three strong magnets further secure the stop to the chuck face.
- Stop allows short parts to project past the chuck jaws, providing **clearance for facing operations**.
- Setup time is greatly reduced – no need to bore soft jaws.
- The Royal Chuck Stop is very accurate – front and back locating surfaces are parallel within +/- 0.0004".
- Accommodates chuck jaws up to 55mm (2 1/8") wide.
- Anodized finish provides good wear-resistance.



Royal Chuck Stop Sets

DESCRIPTION	PART NUMBER	PRICE
Standard Set – includes 15, 20, & 25mm height stops	25200	\$385
Deluxe Set – includes 15, 20, 25, 30, & 35mm height stops	25210	669



ROYAL SENSITIVE DRILL FEED



- Makes drilling of small holes easy.
- Drills small holes independent of coarser standard quill feed.
- Gives operator better **feel and control** of feed rate.
- 3/4" travel.
- Fingertip-controlled feed rate helps prevent walking and deflection.
- Eliminates the need for expensive specialized machines to drill small holes.



Royal Sensitive Drill Feed

SHANK DIA.	CHUCK MOUNT TAPER	PART NUMBER	PRICE
1/2"	Jacobs #0 (DIN B6)	25300	\$123

Price does not include drill chuck pictured.

Simple to Use:

1. Grasp free-turning knurled ring and feed with gentle finger pressure.
2. Drill feed is spring-loaded and retracts automatically when ring is released.