

MILLING AND DRILLING TOOLING SOLUTIONS

- ALBRECHT PRECISION DRILL CHUCKS
- ALBRECHT ER MICRO-CHUCKS FOR
DRIVEN TOOLING
- ULTRA-PRECISION ER COLLETS





ALBRECHT ER MICRO-CHUCKS

Optimize Your Driven Tooling



- ❑ These unique one-piece toolholders provide extra reach and support for your drills and endmills when using driven tooling.
- ❑ Exceptional accuracy and rigidity for:
 - ✓ More aggressive chip removal
 - ✓ Faster cycle times
 - ✓ Improved cutting tool life
- ❑ Integral ER body, super slim nose, and ultra-precision collets work in unison for optimized clearance and superior vibration dampening over shrink-fit holders.
- ❑ Cutting tool life significantly extended.
- ❑ Available in three popular ER configurations for compatibility with many brands of driven tools.
- ❑ Ultra-precision accuracy - 3 microns (0.00012") at 2.5 x diameter.
- ❑ High-speed balanced to G2.5@40,000 rpm.
- ❑ Collets are available from stock in both inch and metric sizes with a choice of precise coolant delivery options:
 - Standard – coolant is directed through the collet slots over the cutting tool.
 - Sealed – coolant is directed through the center of the cutting tool (for cutting tools that have central coolant ports).
- ❑ Simple axial tightening reduces setup time.

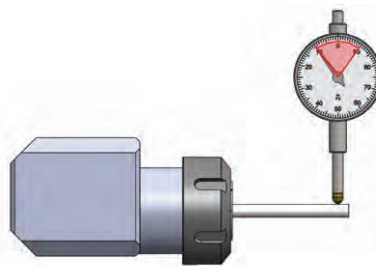

The Old Method

- Small diameter cutting tools flex under load
- Excessive vibration
- Less than optimal cycle times

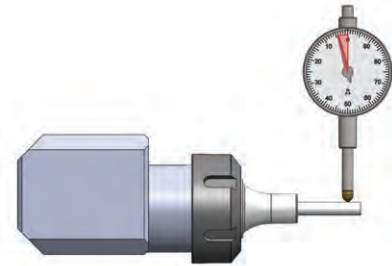

The Albrecht Method

- Cutting tools supported over greater length
- Superior rigidity, accuracy, and dampening
- Faster cycle times



Simple, axial tightening of the collet keeps the tool on centerline and enables fast changeover.

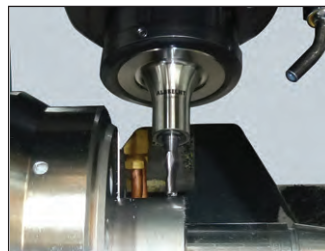

Benefit from additional cutting tool support while maintaining excellent clearance in tight areas.

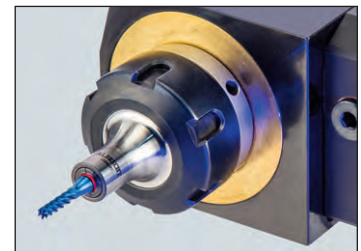

Integral ER body optimizes rigidity and vibration dampening.

ALBRECHT ER MICRO-CHUCKS

Optimize Your Driven Tooling

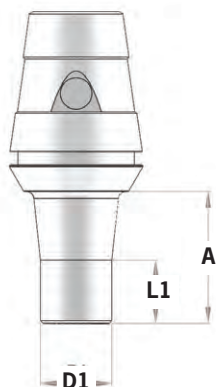

Albrecht Micro-Chuck Bodies

BODY STYLE	A	L1	D1	PART NUMBER	PRICE
ER-20	1.10	1.10	0.53	74660	\$545
ER-20	1.38	1.38	0.53	74662	576
ER-25	0.98	0.47	0.53	74664	557
ER-25	1.57	0.59	0.53	74666	581
ER-25	1.97	0.79	0.53	74668	593
ER-32	0.98	0.47	0.53	74670	576
ER-32	1.57	0.59	0.53	74672	593
ER-32	1.97	0.79	0.53	74674	605

* Order collets separately.

ALBRECHT ER MICRO-CHUCK ULTRA-PRECISION COLLETS

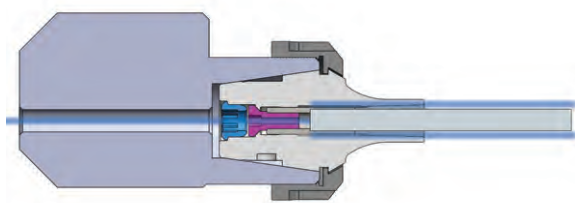

Standard
(Coolant Directed Through Collet Slots)

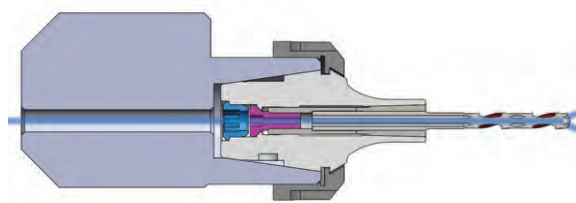

Sealed
(Coolant Directed Through Cutting Tool)



Inch Sizes

DIAMETER	COLLET TYPE	PART NUMBER	PRICE
1/8"	Standard	74610	\$178
1/8"	Sealed	74620	213
3/16"	Standard	74611	178
3/16"	Sealed	74621	213
1/4"	Standard	74612	178
1/4"	Sealed	74622	213

Metric Sizes

DIAMETER	COLLET TYPE	PART NUMBER	PRICE
1mm	Standard	74613	\$328
1mm	Sealed	74623	376
2mm	Standard	74614	197
2mm	Sealed	74624	245
3mm	Standard	74615	171
3mm	Sealed	74625	205
4mm	Standard	74616	171
4mm	Sealed	74626	205
5mm	Standard	74617	171
5mm	Sealed	74627	205
6mm	Standard	74618	171
6mm	Sealed	74628	205



ALBRECHT

The World's Most Consistently Accurate Drill Chucks



For the past 100 years, Albrecht's line of precision drill chucks has consistently earned the highest praise for **outstanding quality and accuracy**.

At the Albrecht factory, located outside of Stuttgart, Germany, in-process air gages and custom test fixtures are used to inspect all components throughout each step of the manufacturing process. Upon assembly, each chuck is qualified with 4–6 different diameter test pins at two distinct locations on each pin, and then a quality control inspector repeats the process with 4–6 different pins before approving the chuck for packaging.

Drill chuck accuracy is critical to producing accurate hole sizing and promoting longer drill life. In today's competitive environment of short lead times and slim margins, a few scrapped parts can quickly kill a job's profits. Can you afford to take a chance on anything less than an Albrecht?

WHAT DOES IT TAKE TO MAKE A CLASSIC?

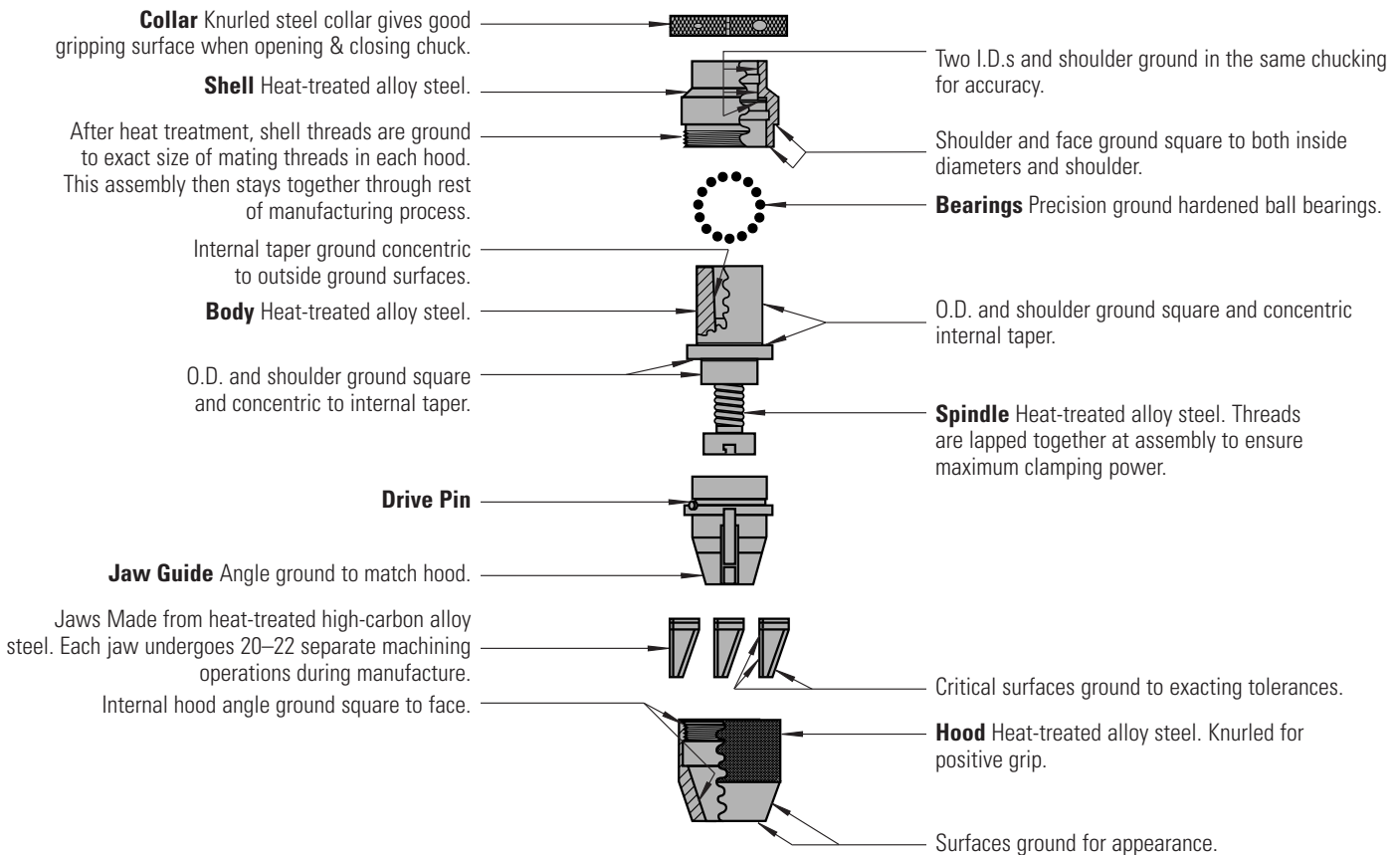

ALBRECHT SELF-TIGHTENING DESIGN



The more torque that is applied to the chuck, the tighter it grips!

All Albrecht Precision Drill Chucks, except for the Key-Lock models, incorporate a unique self-tightening feature that causes them to **grip drills tighter** as more torque is applied.

This self-tightening advantage, combined with the fact that keyless chucks are easily opened by hand, is causing many industries to abandon key-type drill chucks altogether.

ALBRECHT DIAMOND-IMPREGNATED JAWS



**FOR CARBIDE
AND HARDENED-
SHANK DRILLS**

Albrecht's patented diamond-impregnated jaws eliminate the problems of drill slippage and jaw damage that often occur when using carbide or hardened-shank drills.

Because the diamond particles embedded in the jaws are harder than the drill shanks they are gripping, they are **able to penetrate for a deep, no-slip bite.**

ALBRECHT CNC DRILL CHUCKS Excellent for CNC Machining Centers

Royal offers two Albrecht drill chuck models designed specifically for CNC machining centers:



KEY-LOCK



WRENCH-LOCK

CNC Drill Chuck Advantages

Although some manufacturers use collet chucks or toolholders for holding drills, often an Albrecht CNC Drill Chuck would be a better choice.

- A drill chuck can hold any size drill shank within its range. This is important because many tap drills have odd-sized shanks that are not compatible with conventional toolholders and collets.
- As the jaws of a drill chuck close, they always remain parallel to centerline. This results in **uniform gripping force and maximum accuracy**, regardless of the drill shank diameter.

For Best Performance, Equip Your Machining Centers with Albrecht CNC Drill Chucks from Royal



ALBRECHT WRENCH-LOCK PRECISION CNC DRILL CHUCKS

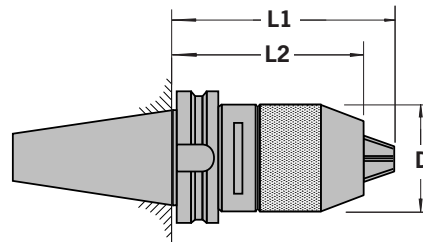
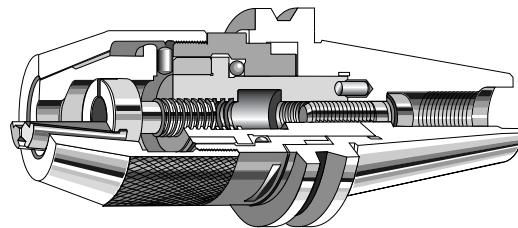

- Internal construction is very similar to Albrecht Classic Drill Chucks.
- Integral CAT taper makes these chucks **shorter and more rigid** than a chuck/arbor combination, resulting in:
 - Greater accuracy
 - Greater rigidity
 - Larger work envelope
- Integral shank eliminates the possibility of a chuck slipping on its arbor.
- Chuck can be easily tightened and opened by hand.
- Extra tightening force can be achieved by using a spanner wrench (included), although this chuck also incorporates the same self-tightening feature as the Classic models (see page 133).

Albrecht Wrench-Lock CNC Drill Chucks

CHUCK MODEL	CAPACITY		SHANK TYPE	D	L1	L2	THREAD	MAXIMUM RPM	WEIGHT (lbs.)	PART NUMBER	PRICE
	(inches)	(millimeters)									
WL130-CAT40	1/2 – 1/2	1–13	CAT 40	2"	3 15/16"	4 7/16"	5/8–11	6,500	4.6	77100	\$743
WL160-CAT40	1/16 – 5/8	1.5–16	CAT 40	2 1/4"	4 1/32"	4 5/8"	5/8–11	6,500	5.1	77110	839
WL160-CAT50	1/16 – 5/8	1.5–16	CAT 50	2 1/4"	4 1/32"	4 5/8"	1–8	6,500	6.2	77120	976

ALBRECHT KEY-LOCK PRECISION CNC DRILL CHUCKS



- New, compact design provides **increased capacity and better clearance.**
- Extremely accurate – Albrecht Key-Lock Drill Chucks are the most accurate drill chucks available.
- Unique worm/gear arrangement is similar to the Überchuck and transmits extremely high gripping force to the jaws.
- Short length and integral shank provide **exceptional rigidity.**
- Thru-coolant feature is standard on all Albrecht Key-Lock Drill Chucks.
- Non-rotating hood – chuck is opened and closed via a hex key inserted into the side of the body.
- Balanced to G2.5 @ 20,000 rpm for use on all CNC machines.
- Can be operated in both clockwise and counterclockwise directions.

Thru-coolant feature is standard on all Key-Lock chucks.

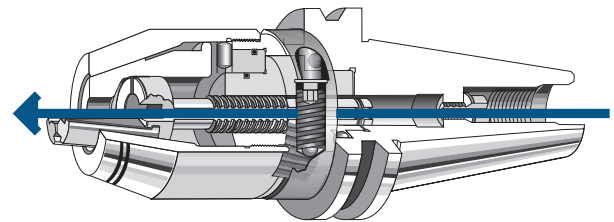

The key-operated worm and gear assembly generates **very high grip force** and ensures that the chuck can't loosen during operation because a worm can drive a gear, but a gear cannot drive a worm.

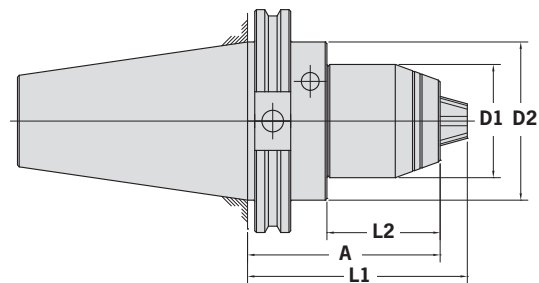
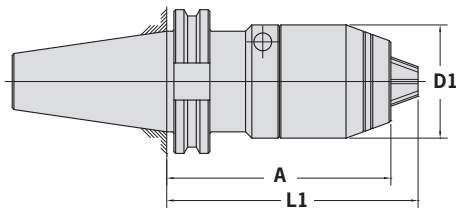

Albrecht Key-Lock CNC Drill Chucks

CHUCK MODEL	CAPACITY (inches)	CAPACITY (millimeters)	TAPER	A	L1	L2	D1	PART D2	WEIGHT (lbs.)	NUMBER	PRICE
KL100-CAT40	1/64 – 3/8	0.5 – 10	CAT 40	2.72	3.39	1.48	1.50	1.75	2.8	75402	\$847
KL160-HSK 63 Form A	1/32 – 5/8	1 – 16	HSK 63 Form A	3.86	4.33	–	1.97	–	3.4	75403	858
KL160-HSK 63 Form F	1/32 – 5/8	1 – 16	HSK 63 Form F	3.86	4.33	–	1.97	–	3.5	75408	1,035
KL160-CAT40	1/32 – 5/8	1 – 16	CAT 40	3.90	4.37	–	1.97	–	2.7	75404	776
KL160-CAT50	1/32 – 5/8	1 – 16	CAT 50	3.31	3.78	1.93	1.97	2.76	7.9	75406	1,045

Note – Other tapers available. Please contact Royal at 1-800-645-4174.



ALBRECHT CLASSIC PRECISION KEYLESS DRILL CHUCKS

The World's Most Consistently Accurate Drill Chucks

- Available in the following styles:
 - Standard
 - Thru-hole
 - Diamond-coated jaws
 - Stainless Steel
- Keyless operation.
- Self-tightening design (see page 133).
- Balanced.
- Stainless steel models with threaded mount for corrosive applications such as EDM.
- Thru-hole models are great for EDM applications and also allow the use of longer drills.
- Models with diamond-coated jaws **effectively grip carbide-shank drills** (see page 133).
- Threaded-mount models available upon request.

Dimensions

CHUCK MODEL	D	L1	L2
15	0.75	1.38	1.50
30	1.00	1.75	1.88
50	1.19	2.25	2.44
65	1.38	2.44	2.69
100	1.69	3.13	3.63
130	2.00	3.56	4.06
160	2.25	3.75	4.31

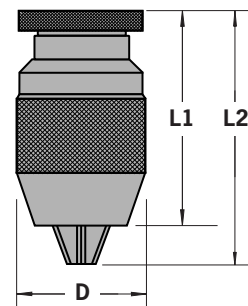

Albrecht Classic Keyless Drill Chucks



CHUCK MODEL	CAPACITY		CHUCK MOUNT	MAXIMUM RPM	WEIGHT (lbs.)	PART NUMBER	PRICE
	(inches)	(millimeters)					
15-J0	0* - 1/16	0* - 1.5	J0	50,000	0.1	70010	\$641
30-J0	0* - 1/8	0* - 3	J0	35,000	0.2	70020	483
30-J1	0* - 1/8	0* - 3	J1	35,000	0.2	70030	483
65-J1	0* - 1/4	0* - 6.5	J1	20,000	0.7	70050	462
100-J33	0* - 3/8	0* - 10	J33	12,000	1.4	70070	499
100-J2	0* - 3/8	0* - 10	J2	12,000	1.4	70080	499
130-J33	1/32* - 1/2	1* - 13	J33	7,000	2.1	70090	547
130-J2	1/32* - 1/2	1* - 13	J2	7,000	2.1	70100	547
130-J6	1/32* - 1/2	1* - 13	J6	7,000	2.1	70110	547
160-J6	1/32* - 5/8	1* - 16	J6	4,000	2.8	70120	618

* The inherent design characteristics of a keyless drill chuck may prevent the jaws from closing down to absolute zero. Albrecht guarantees a minimum gripping diameter of 0.008" for model 15 Keyless Drill Chucks, and 0.015" for Models 30 – 100 Keyless Drill Chucks. If you need to grip a smaller diameter, please contact us at 1-800-645-4174.

ALBRECHT CLASSIC PRECISION KEYLESS DRILL CHUCKS



Albrecht Classic Keyless Drill Chuck with Thru-Hole

CHUCK MODEL	CAPACITY		THRU-HOLE DIA.	CHUCK MOUNT	MAXIMUM RPM	WEIGHT (lbs.)	PART NUMBER	PRICE
	(inches)	(millimeters)						
15-J0	0* - 1/16	0* - 1.5	1.8	J0	50,000	0.1	73500	\$658
30-J0	0* - 1/8	0* - 3	3	J0	35,000	0.2	73510	477
30-J1	0* - 1/8	0* - 3	3	J1	35,000	0.2	73520	477



**FOR CARBIDE
AND HARDENED-
SHANK DRILLS**

Albrecht Classic Keyless Drill Chuck with Diamond Jaws

CHUCK MODEL	CAPACITY		CHUCK MOUNT	MAXIMUM RPM	WEIGHT (lbs.)	PART NUMBER	PRICE
	(inches)	(millimeters)					
130-J33	1/32 - 1/2	1-11	J33	7,000	2.1	70290	\$799
130-J6	1/32 - 1/2	1-13	J6	7,000	2.1	70300	799



Albrecht Stainless Steel Classic Keyless Drill Chucks

CHUCK MODEL	CAPACITY		THRU-HOLE DIA.	CHUCK MOUNT	MAXIMUM RPM	WEIGHT (lbs.)	PART NUMBER	PRICE
	(inches)	(millimeters)						
30-3/8	0 - 1/8	0* - 3	3	3/8-24	7,500	0.3	73700	\$773
50-3/8	1/32 - 1/4	0.6 - 7.4	4	3/8-24	5,000	0.5	73710	830

Note - These stainless steel chucks are for industrial use only. Special Chucks available for medical/surgical applications. Please contact us at 1-800-645-4174.



ALBRECHT CLASSIC-PLUS PRECISION DRILL CHUCKS WITH INTEGRAL SHANK

- Integral shank design is more compact than a combined drill chuck and arbor, resulting in:
 - Greater accuracy
 - Greater rigidity
 - Larger work envelope
- Integral shank eliminates the possibility of a chuck slipping on its arbor.
- This unit is often **less expensive than a separate chuck and arbor.**
- Keyless operation.
- Self-tightening design (see page 133).
- Balanced.
- Available with standard or diamond-coated jaws (💎 see page 133).

Dimensions

CHUCK MODEL	D	L1	L2
130-2MT	2"	3 ³ / ₈ "	3 ⁷ / ₈ "
130-3MT	2"	3 ³ / ₈ "	3 ⁷ / ₈ "
130-4MT	2"	3 ⁷ / ₁₆ "	3 ¹⁵ / ₁₆ "
130-R8	2"	3 ⁵ / ₁₆ "	3 ¹³ / ₁₆ "
130-5/8	2"	3 ¹ / ₈ "	3 ⁵ / ₈ "

CHUCK MODEL	D	L1	L2
160-2MT	2 ¹ / ₄ "	3 ¹ / ₂ "	4 ¹ / ₁₆ "
160-3MT	2 ¹ / ₄ "	3 ¹ / ₂ "	4 ¹ / ₁₆ "
160-4MT	2 ¹ / ₄ "	3 ⁹ / ₁₆ "	4 ¹ / ₁₆ "
160-R8	2 ¹ / ₄ "	3 ⁷ / ₁₆ "	3 ¹⁵ / ₁₆ "

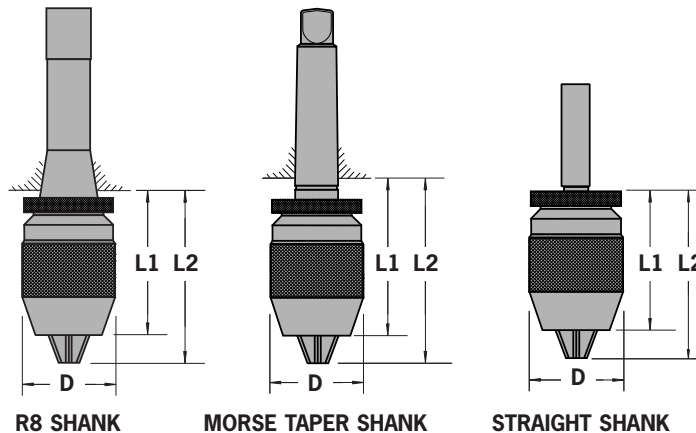

Albrecht Classic-Plus Precision Keyless Drill Chucks with Integral Shank



CHUCK MODEL	CAPACITY (inches)	CAPACITY (millimeters)	SHANK TYPE	MAXIMUM RPM	WEIGHT (lbs.)	PART NUMBER	PRICE
CP130-2MT	1/32 – 1/2	1–13	2MT	7,000	2.3	73010	\$609
CP130-3MT	1/32 – 1/2	1–13	3MT	7,000	2.6	73020	612
CP130-4MT	1/32 – 1/2	1–13	4MT	7,000	3.3	73030	645
CP130-R8	1/32 – 1/2	1–13	R8	7,000	2.6	73040	669
CP130-5/8	1/32 – 1/2	1–13	5/8"SS	7,000	2.2	73050	605
CP160-2MT	1/8 – 5/8	3–16	2MT	4,000	2.9	73060	675
CP160-3MT	1/8 – 5/8	3–16	3MT	4,000	3.3	73070	679
CP160-4MT	1/8 – 5/8	3–16	4MT	4,000	4.0	73080	713
CP160-R8	1/8 – 5/8	3–16	R8	4,000	4.2	73090	735

Albrecht Classic-Plus Precision Keyless Drill Chucks with Integral Shank and Diamond-Coated Jaws



FOR CARBIDE AND HARDENED-SHANK DRILLS

CHUCK MODEL	CAPACITY (inches)	CAPACITY (millimeters)	SHANK TYPE	MAXIMUM RPM	WEIGHT (lbs.)	PART NUMBER	PRICE
CPD130-2MT	1/32 – 1/2	1–13	2MT	7,000	2.3	73110	\$864
CPD130-3MT	1/32 – 1/2	1–13	3MT	7,000	2.6	73120	890
CPD130-4MT	1/32 – 1/2	1–13	4MT	7,000	3.3	73130	906
CPD130-R8	1/32 – 1/2	1–13	R8	7,000	2.6	73140	929
CPD130-5/8	1/32 – 1/2	1–13	5/8"SS	7,000	2.2	73150	863

ALBRECHT PRECISION ARBORS



- ❑ Manufactured from high-grade alloy steels.
- ❑ Hardened for long life.
- ❑ Ground concentric within 0.0001".
- ❑ Guarantee: If an Albrecht chuck ever slips on an Albrecht arbor, we **will repair or replace them at no charge.**

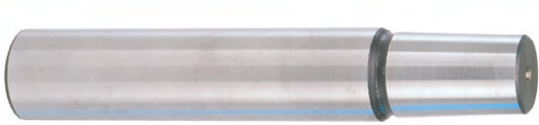

Straight Shank

SHANK DIAMETER	SHANK LENGTH	CHUCK TAPER	PART NUMBER	PRICE
3/8"	2 1/2"	J0	70580	\$85
3/8"	2 1/2"	J1	70583	90
1/2"	2 1/2"	J0	70586	85
1/2"	2 1/2"	J1	70589	90
1/2"	2 1/2"	J2	70592	105
1/2"	2 1/2"	J33	70595	134
1/2"	2 1/2"	J6	70598	134
5/8"	2 1/2"	J1	70601	134
5/8"	2 1/2"	J33	70607	134
5/8"	2 1/2"	J6	70610	134
3/4"	3"	J2	70616	149
3/4"	3"	J6	70619	149
1"	3"	J33	70625	149

ALBRECHT ACCESSORIES

SENSITIVE DRILL FEEDS

- ❑ Makes drilling of small holes easy by giving operator fingertip feed control independent of coarser quill feed.
- ❑ Eliminates the need for special machines to drill small holes.
- ❑ **Reduces breakage and deflection of small drills.**

Simple to use:

1. Grasp free-turning knurled ring and feed with gentle finger pressure.
2. Spring-loaded. When ring is released, chuck retracts automatically.



Note: Spring is specifically balanced for use with model 15-J0. The use of other chucks could result in decreased accuracy and performance.

SHANK	TAPER	PART NUMBER	PRICE
1 Morse Taper	J0	70670	\$582
1/2" Diameter	J0	70675	528

CHUCK REMOVAL TOOLS

- ❑ Tapered chuck removal tool can be used to remove the chucks from their mounts.
- ❑ Simply match the Jacobs taper on the chuck to the corresponding tool.

CHUCK MOUNT	PART NUMBER	PRICE
J0	70678	\$85
J1	70680	121
J2	70682	130
J33	70682	130
J6	70682	130





ALBRECHT CHUCK REFURBISHING

Send It In or Do It Yourself

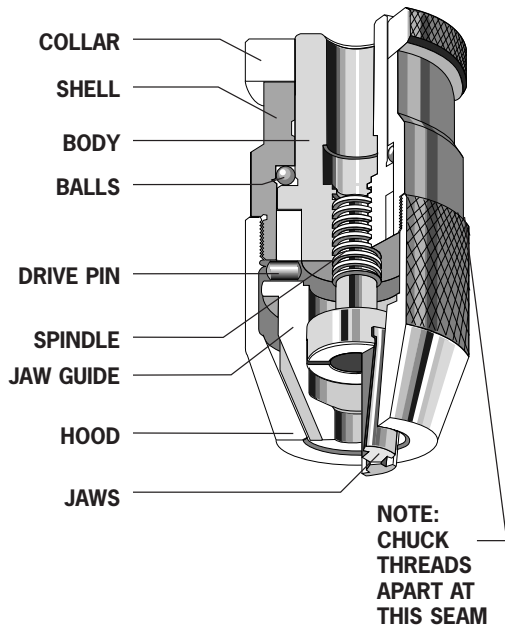

Many customers refurbish their own chucks by following these simple instructions. If you have questions regarding the refurbishing process, please call one of our applications engineers at 1-800-645-4174, or visit www.royalproducts.com.

- Remove collar from chuck.
- There is an invisible seam between the hood and shell. Hold chuck by the shell in a vise with soft jaws and loosen hood with a strap wrench – RH thread.
- Once the hood has been loosened, unscrew by hand to prevent distortion.
- Slide jaws out of jaw guide and remove guide.
- Remove body and spindle assembly to expose balls.
- Clean all parts with a mild solvent.
- Replace worn or damaged parts.
- Reverse steps for assembly.

Caution – do not lubricate acme thread on body/spindle assembly. Thread must be clean and dry for chuck to work correctly.

If you prefer to send your chucks back to our factory for refurbishing, please send them to the address listed in this catalog. Be sure to include your name, telephone number, and either a fax number or email address so we can send you a free, no-obligation quotation. If our technicians determine that a chuck is beyond reasonable refurbishing condition, you will be offered a brand new Albrecht chuck at a discounted price.

ALBRECHT REPLACEMENT PARTS

Classic Keyless Drill Chucks

CHUCK MODEL	BODY & SPINDLE ASSEMBLY		JAWS		HOOD		BALLS (Set)		COLLAR		SHELL		JAW GUIDE		DRIVE PIN	
	PART NUMBER	PRICE	PART NUMBER	PRICE	PART NUMBER	PRICE	PART NUMBER	PRICE	PART NUMBER	PRICE	PART NUMBER	PRICE	PART NUMBER	PRICE	PART NUMBER	PRICE
C15-J0	70796	\$167	70700	\$212	70716	\$117	70732	\$20	70748	\$146	70764	\$83	70780	\$183	71002	\$9
C30-J0	70798	136	70702	189	70718	125	70734	15	70750	160	70766	64	70782	168	71004	9
C30-J1	70800	136	70702	189	70718	125	70734	15	70750	160	70766	64	70782	168	71004	9
C65-J1	70804	146	70706	189	70722	125	70738	15	70754	57	70770	69	70786	101	71008	9
C100-J33	70808	178	70710	189	70726	138	70742	15	70758	58	70774	83	70790	105	71012	9
C100-J2	70810	178	70710	189	70726	138	70742	15	70758	58	70774	83	70790	105	71012	9
C130-J33	70812	178	70712	189	70728	176	70744	20	70760	59	70776	83	70792	105	71014	9
C130-J2	70814	178	70712	189	70728	176	70744	20	70760	59	70776	83	70792	105	71014	9
C130-J6	70816	178	70712	189	70728	176	70744	20	70760	59	70776	83	70792	105	71014	9
C160-J6	70818	196	70714	189	70730	197	70746	20	70762	64	70778	95	70794	118	71016	9

Classic-Plus Keyless Drill Chucks

CHUCK MODEL	BODY & SPINDLE ASSEMBLY		JAWS		HOOD		BALLS (Set)		COLLAR		SHELL		JAW GUIDE		DRIVE PIN	
	PART NUMBER	PRICE	PART NUMBER	PRICE	PART NUMBER	PRICE	PART NUMBER	PRICE	PART NUMBER	PRICE	PART NUMBER	PRICE	PART NUMBER	PRICE	PART NUMBER	PRICE
CP130-2MT	73250	\$245	70712	\$189	70728	\$176	73220	\$42	73210	\$64	73200	\$83	70792	\$105	71014	\$9
CP130-3MT	73260	263	70712	189	70728	176	73220	42	73210	64	73200	83	70792	105	71014	9
CP130-4MT	73270	293	70712	189	70728	176	73220	42	73210	64	73200	83	70792	105	71014	9
CP130-5/8	73290	238	70712	189	70728	176	73220	42	73210	64	73200	83	70792	105	71014	9
CP130-R8	74040	302	70712	189	70728	176	73220	42	73210	64	73200	83	70792	105	71014	9
CP160-2MT	74044	340	70714	189	70730	197	70747	20	70763	64	73205	95	70794	118	71016	9
CP160-3MT	74042	293	70714	189	70730	197	70747	20	70763	64	73205	95	70794	118	71016	9
CP160-4MT	74041	329	70714	189	70730	197	70747	20	70763	64	73205	95	70794	118	71016	9
CP160-R8	74043	340	70714	189	70730	197	70747	20	70763	64	73205	95	70794	118	71016	9

ROYAL ULTRA-PRECISION ER COLLETS – 0.0002" TIR



Inch and Metric Sizes

Royal ER Collets are available in both **inch and metric sizes**. This optimizes the surface contact between the collet and cutting tool and results in higher accuracies, stronger grip force, better part finishes, and longer cutting tool life.

Extremely Accurate

Runout is guaranteed to be 6 microns (**0.0002" TIR**), or better. Each collet is inspected to this standard prior to shipping.

Heavy Duty Construction

Royal ER Collets are made from high-grade steels imported from Germany and are hardened for long life.



Sealed Models Available

For precise coolant delivery to the tip of the cutting tool.

Large Inventory

All sizes are **in-stock**, ready for immediate shipment.

Wide Gripping Range

Royal standard ER Collets contain 16 slots, providing a larger gripping range than other brands.

Great Value

Very **competitive prices** make these high-quality ER Collets the best value in the industry.

ROYAL **SEALED** ULTRA-PRECISION ER COLLETS

Short slots block flow, ensuring that all coolant is delivered thru the cutting tool.

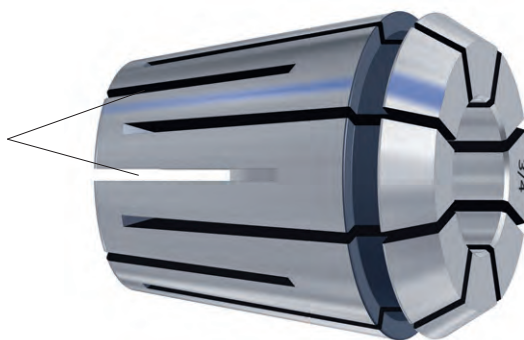

- Ultra-Precision Accuracy – 0.0002" TIR guaranteed.
- **High-pressure approved to 1400 psi.**
- Unique design is mechanically sealed by virtue of the rear slots terminating prior to the annular groove, completely blocking the path of coolant flow to the front of the collet.
- When using thru-coolant cutting tools, these collets ensure **100% coolant delivery** to the tip of the cutting tool.
- Superior to collets sealed with silicone/rubber plugs because plugs are limited to lower operating pressures and are subject to wear.
- Unlike standard ER collets, sealed models do not have a wide collapsibility range, requiring the collet bore to be matched to the cutting tool shank diameter.

A Perfect Match to Your Cutting Tool Diameter

All Royal ER Collets are available from stock in both inch and metric sizes. This is very important because it enables you to select a collet that has been ground to your precise cutting tool size.

Using a collet that is **perfectly matched to the cutting tool diameter** ensures that full surface contact is achieved, resulting in higher gripping force, better accuracy, less vibration, better surface finishes, and longer tool life.

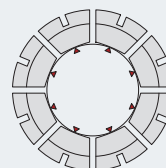

Other Brands

Single Point Contact when Using Metric Collets to Hold Inch-Sized Tooling, or Vice Versa

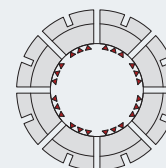

Royal Brand

Full Surface Contact Because Royal ER Collets are Ground to Exact Inch and Metric Sizes



ULTRA-PRECISION ER COLLETS – 0.0002" TIR

Standard and Sealed

Inch Sizes



ER-11
\$37 / \$41



ER-16
\$37 / \$41



ER-20
\$41 / \$48



ER-25
\$43 / \$50



ER-32
\$46 / \$54



ER-40
\$50 / \$62

Royal Ultra-Precision ER Collets (Inch)

DRILL/ENDMILL DIAMETER	STANDARD COLLET GRIP RANGE*	ER-11*		ER-16		ER-20		ER-25		ER-32		ER-40	
		Standard \$37	Sealed \$41	Standard \$37	Sealed \$41	Standard \$41	Sealed \$48	Standard \$43	Sealed \$50	Standard \$46	Sealed \$54	Standard \$50	Sealed \$62
1/16"	.062 – .043	53002		53020		53050		53090					
3/32"	.093 – .054	53004		53022		53052		53092		53140			
1/8"	.125 – .086	53006	56006	53024	56024	53054	56054	53094	56094	53142		53200	
5/32"	.156 – .117	53008	56008	53026	56026	53056	56056	53096	56096	53144	56144	53202	56202
3/16"	.187 – .148	53010	56010	53028	56028	53058	56058	53098	56098	53146	56146	53204	56204
7/32"	.218 – .179	53012	56012	53030	56030	53060	56060	53100	56100	53148	56148	53206	56206
1/4"	.250 – .211	53014	56014	53032	56032	53062	56062	53102	56102	53150	56150	53208	56208
9/32"	.281 – .242			53034	56034	53064	56064	53104	56104	53152	56152	53210	56210
5/16"	.312 – .273			53036	56036	53066	56066	53106	56106	53154	56154	53212	56212
11/32"	.343 – .304			53038	56038	53068	56068	53108	56108	53156	56156	53214	56214
3/8"	.375 – .336			53040	56040	53070	56070	53110	56110	53158	56158	53216	56216
13/32"	.406 – .367			53042	56042	53072	56072	53112	56112	53160	56160	53218	56218
7/16"	.437 – .398					53074	56074	53114	56114	53162	56162	53220	56220
15/32"	.468 – .429					53076	56076	53116	56116	53164	56164	53222	56222
1/2"	.500 – .461					53078	56078	53118	56118	53166	56166	53224	56224
17/32"	.531 – .492							53120	56120	53168	56168	53226	56226
9/16"	.562 – .523							53122	56122	53170	56170	53228	56228
19/32"	.593 – .554							53124	56124	53172	56172	53230	56230
5/8"	.625 – .586							53126	56126	53174	56174	53232	56232
21/32"	.656 – .617									53176	56176	53234	56234
11/16"	.687 – .648									53178	56178	53236	56236
23/32"	.718 – .679									53180	56180	53238	56238
3/4"	.750 – .711									53182	56182	53240	56240
25/32"	.781 – .742									53184	56184	53242	56242
13/16"	.812 – .773									53186	56186	53244	56244
27/32"	.843 – .804											53246	56246
7/8"	.875 – .836											53248	56248
29/32"	.906 – .867											53250	56250
15/16"	.937 – .898											53252	56252
31/32"	.969 – .930											53254	56254
1"	1.000 – .961											53256	56256

* Gripping range for ER-11 is 1/64". Sealed collets have no range – must be sized exactly.



ULTRA-PRECISION ER COLLETS – 0.0002" TIR

Standard and Sealed

Metric Sizes



ER-11
\$37 / \$41



ER-16
\$37 / \$41



ER-20
\$41 / \$48



ER-25
\$43 / \$50



ER-32
\$46 / \$54



ER-40
\$50 / \$62

Royal Ultra-Precision ER Collets (Metric)

DRILL/ENDMILL DIAMETER	STANDARD COLLET GRIP RANGE*	ER-11*		ER-16		ER-20		ER-25		ER-32		ER-40	
		Standard \$37	Sealed \$41	Standard \$37	Sealed \$41	Standard \$41	Sealed \$48	Standard \$43	Sealed \$50	Standard \$46	Sealed \$54	Standard \$50	Sealed \$62
1 mm	1 – 0.5	53402		53430									
2 mm	2 – 1	53404		53432		53460		53502					
3 mm	3 – 2	53406	56406	53434	56434	53462	56462	53504	56504	53550			
4 mm	4 – 3	53408	56408	53436	56436	53464	56464	53506	56506	53552	56552	53602	56602
5 mm	5 – 4	53410	56410	53438	56438	53466	56466	53508	56508	53554	56554	53604	56604
6 mm	6 – 5	53412	56412	53440	56440	53468	56468	53510	56510	53556	56556	53606	56606
7 mm	7 – 6	53414	56414	53442	56442	53470	56470	53512	56512	53558	56558	53608	56608
8 mm	8 – 7			53444	56444	53472	56472	53514	56514	53560	56560	53610	56610
9 mm	9 – 8			53446	56446	53474	56474	53516	56516	53562	56562	53612	56612
10 mm	10 – 9			53448	56448	53476	56476	53518	56518	53564	56564	53614	56614
11 mm	11 – 10					53478	56478	53520	56520	53566	56566	53616	56616
12 mm	12 – 11					53480	56480	53522	56522	53568	56568	53618	56618
13 mm	13 – 12					53482	56482	53524	56524	53570	56570	53620	56620
14 mm	14 – 13							53526	56526	53572	56572	53622	56622
15 mm	15 – 14							53528	56528	53574	56574	53624	56624
16 mm	16 – 15							53530	56530	53576	56576	53626	56626
17 mm	17 – 16									53578	56578	53628	56628
18 mm	18 – 17									53580	56580	53630	56630
19 mm	19 – 18									53582	56582	53632	56632
20 mm	20 – 19									53584	56584	53634	56634
21 mm	21 – 20											53636	56636
22 mm	22 – 21											53638	56638
23 mm	23 – 22											53640	56640
24 mm	24 – 23											53642	56642
25 mm	25 – 24											53644	56644
26 mm	26 – 25											53646	56646

* Gripping range for ER-11 is 0.5 mm. Sealed collets have no range – must be sized exactly.



ROYAL ULTRA-PRECISION ER COLLET SETS

Standard and Sealed



- 0.0002" TIR guaranteed.
- Convenient sets include all popular sizes.
- Available in inch, metric, standard, and sealed models.

Royal ER Collet Sets (Inch – Standard)

COLLET SERIES	RANGE	NUMBER OF COLLETS IN SET	PART NUMBER	PRICE
ER-11	1/16"–1/4" x 32nds	7	53300	\$259
ER-16	1/16"–3/8" x 32nds	11	53302	407
ER-20	5/32"–1/2" x 32nds	12	53304	492
ER-25	5/32"–5/8" x 32nds	16	53306	688
ER-32	7/32"–3/4" x 32nds	18	53308	828
ER-40	1/8"–1" x 16ths	15	53310	750

Royal ER Collet Sets (Metric – Standard)

COLLET SERIES	RANGE	NUMBER OF COLLETS IN SET	PART NUMBER	PRICE
ER-11	1–7 mm x 1 mm	7	53700	\$259
ER-16	1–10 mm x 1 mm	10	53702	370
ER-20	2–13 mm x 1 mm	12	53704	492
ER-25	2–16 mm x 1 mm	15	53706	645
ER-32	3–20 mm x 1 mm	18	53708	828
ER-40	4–26 mm x 1 mm	23	53710	1,150

Royal ER Collet Sets (Inch – Sealed*)

COLLET SERIES	RANGE	NUMBER OF COLLETS IN SET	PART NUMBER	PRICE
ER-16	1/8"–3/8" x 32nds	9	56302	\$369
ER-20	5/32"–1/2" x 32nds	12	56304	576
ER-25	5/32"–5/8" x 32nds	16	56306	800
ER-32	7/32"–3/4" x 32nds	18	56308	972
ER-40	3/16"–1" x 16ths	14	56310	868

* Unlike standard ER collets, sealed models do not have a wide collapsibility range and therefore must be sized to the cutting tool diameter.

Royal ER Collet Sets (Metric – Sealed*)

COLLET SERIES	RANGE	NUMBER OF COLLETS IN SET	PART NUMBER	PRICE
ER-16	3–10 mm x 1 mm	8	56702	\$328
ER-20	3–13 mm x 1 mm	11	56704	528
ER-25	3–16 mm x 1 mm	14	56706	700
ER-32	4–20 mm x 1 mm	17	56708	918
ER-40	4–26 mm x 1 mm	23	56710	1,426

* Unlike standard ER collets, sealed models do not have a wide collapsibility range and therefore must be sized to the cutting tool diameter.



ROYAL BRINGS INCREASED PRODUCTIVITY DIRECTLY TO YOUR COMPANY PARKING LOT



Not Able to Visit a Tradeshow?

No problem – with Royal's nationwide fleet of fully-equipped mobile showrooms, **we can bring the show right to your company parking lot.**

Each of our demo vans is outfitted with dozens of productivity-enhancing CNC metalworking accessories that you and your team can see/touch/try firsthand, and then determine for yourselves how they might bring value to your company.

Schedule your visit today at royalproducts.com



UNSURE? ROYAL HAS YOU COVERED!

With Royal's exclusive Risk-Free Performance Guarantee, **you can try many of our products on the toughest jobs in your shop for 45-days**, and if you aren't 100% satisfied with the performance, we'll take it back and arrange for a full refund.

How can we offer such a guarantee? It's simple – our products are all designed and built to outperform expectations, and very few customers are ever disappointed.

We understand that implementing new technology can be scary, and we are happy to alleviate your concerns by removing the risk.

Call us today at 1-800-645-4174 to find out more.