

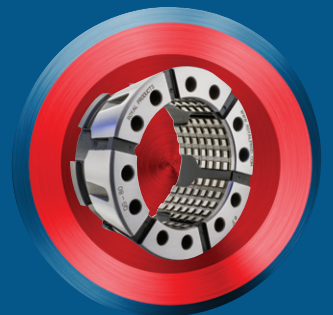

QUICK-GRIP™ WORKHOLDING

- TEN-SECOND COLLET CHANGES
- 0.0002" TIR OR BETTER
- PARALLEL GRIP COLLETS WITH A WIDE RANGE
- MOST COMPACT CHUCKS IN THE INDUSTRY
- IN-STOCK FOR SAME-DAY SHIPPING

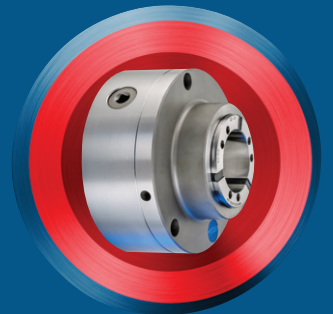

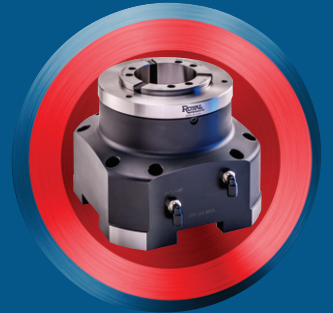

ROYAL QUICK-GRIP™ CNC COLLET CHUCKS

The Most Advanced Collet Chucks Available for Today's CNC Lathes



- ✓ Ten-Second Collet Changes Slash Setup Times.
- ✓ Industry-Leading Gripping Range – 0.062" (0.080" for QG-100).
- ✓ Ultra-Precision Accuracy – 0.0002" TIR Guaranteed.
- ✓ Extreme Grip Force = Most Aggressive Chip Removal Rates and Fastest Cycle Times.
- ✓ Maximum Rigidity Produces Superior Part Finishes.
- ✓ Best Tool Clearance – Critical For Live Tooling.
- ✓ Exclusive Royal Risk-Free Performance Guarantee.
- ✓ In-Stock for Same-Day Shipping.



Three Unique Models For All Applications



Accu-Length™

- Our best-selling model.
- Fixed-position collet maintains precise z-axis part positioning – critical for secondary operations.
- Usually the best choice for main spindles, and always required for sub-spindles to ensure proper part transfer.



Pull-to-a-Stop

- Pullback design, however z-axis part positioning can be controlled with an included internal stop.
- Stop is easily removed for bar work.
- Often used in robot-load applications where workpiece confirmation is required.



Pullback

- Most economical choice, but limited primarily to first operation, main-spindle applications.
- No ability to control z-axis part position.

NOTE – In order to provide our customers with the best possible service, Royal maintains a huge inventory of Quick-Grip™ CNC Collet Chucks, plus more than 375 unique drawtube connector models – enabling same-day shipping on virtually all collet chuck orders.

ROYAL QUICK-GRIP™ CNC COLLET CHUCKS



Big Benefit #1 Ten-Second Collet Changes

With the Royal Quick-Grip™ CNC Collet Chuck, collet changes take just seconds. Here's how it works:

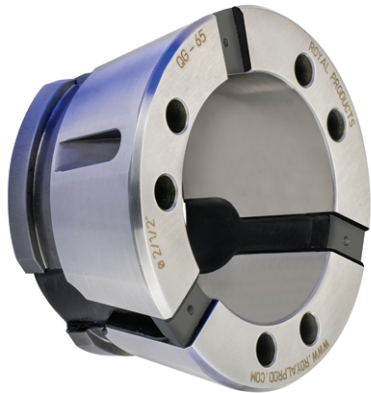

1. The unique collets are constructed of hardened steel segments securely joined together by vulcanized rubber. Each collet contains an annular hook and groove configuration on the rear section of its outer diameter.

2. The installation tool incorporates steel pins that align with reamed holes on the collet face. When these pins engage the face holes and the trigger on the tool is actuated, the collet becomes temporarily compressed.

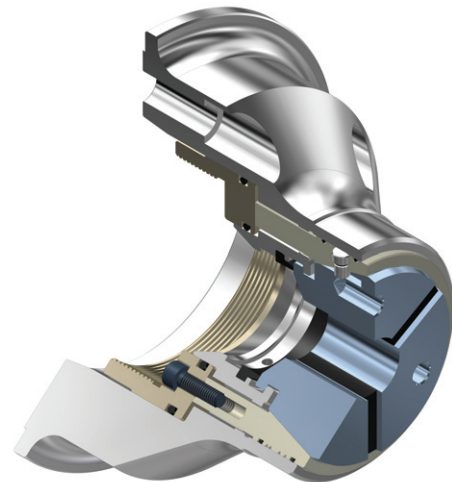

3. In its compressed state, the collet can then be inserted into the collet chuck, where the hooks on the rear of the collet segments become axially aligned with a retaining groove in the chuck.

4. Releasing the installation tool allows the collet to spring open, seating the hooks in the groove and drawing the matching ID/OD tapers into full, positive contact. The collet is now installed.

REDUCED SETUP TIME = GREATER THROUGHPUT AND HIGHER PROFITS!



ROYAL QUICK-GRIP™ CNC COLLET CHUCKS

Big Benefit #2

Ultra-Precision Accuracy – 0.0002" or Better

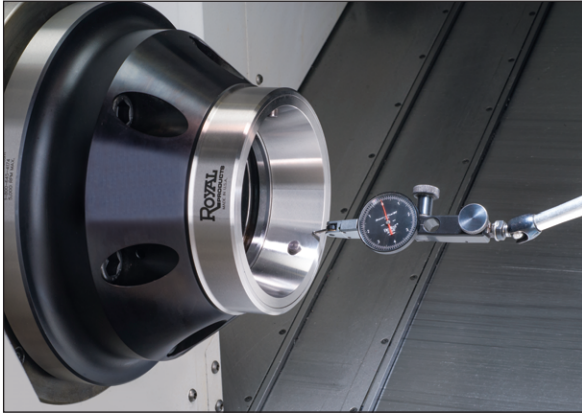

While many users purchase the Royal Quick-Grip™ CNC Collet Chuck for its lightning-fast collet changes and wide gripping range, another major benefit of this system is its extreme accuracy.

With CNC collet chucks, there are several factors which affect overall system accuracy. These include:

- Accuracy and tolerance of chuck mount (taper angle, gage line diameter, squareness of mounting flange, etc.)
- Tolerance and fit between chuck components (body to mounting adapter, closing sleeve to chuck bore, etc.)
- Accuracy and tolerance of collets (OD collet angle, bore sizing, concentricity of ID to OD, etc.)

The manufacturing processes for Royal CNC collet chucks and collets have all been fully optimized to achieve the absolute tightest tolerances and highest accuracies. While we guarantee our chucks at 0.0002" TIR between the A-mount taper and collet chuck closing sleeve, they often run at 0.00005" or better! Round-bore collet accuracy is also guaranteed to be within 0.0002" TIR.

This means that out of the box, with absolutely no indicating in, you can expect to achieve a **Quick-Grip™ total system accuracy of 0.0004" TIR or better.** We know of no other collet chuck manufacturer that can consistently produce such an exact level of precision.

How much time do you waste boring jaws? The Royal Quick-Grip™ pays for itself in no time.

Big Benefit #3

Industry-Leading Gripping Range – 0.062"/0.080"

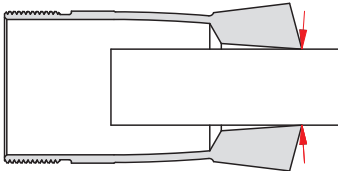

Spring-Type Collet

With a spring-type collet, unless the bore is exactly sized to the workpiece diameter there will be reduced contact, resulting in compromised accuracy and grip force.

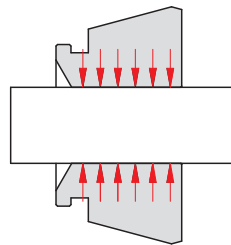

Quick-Grip Collet

With a Quick-Grip™ collet, the segments always remain parallel to the workpiece, helping to maintain optimum accuracy and grip force.

Royal Quick-Grip™ Collets have a **much wider collapse range than conventional spring collets.** A spring-type collet can only be compressed by up to 0.005" before there is a sharp drop off in both grip force and accuracy due to the changing angle of the gripping surface.

However, with the unique design of the Royal Quick-Grip™ collet, each collet segment is bonded to the adjacent segments with vulcanized rubber. This ensures that **the collet segments always remain parallel to the workpiece** as the collet is compressed, giving the Quick-Grip™ collet a full collapse range of .062" (nominal diameter +/- .031). For the QG-100, this range is even greater – 0.080"!

Advantages of this system include:

- The ability to compensate for oversized and undersized bar stock.
- Superior accuracy and grip force – by remaining parallel to the workpiece, each collet segment **makes contact over its entire length.** With old-technology spring collets, over-collapsing results in just a narrow ring of contact near the collet face.
- The wide range of the Royal Quick-Grip™ collet provides the ability to clear larger diameters in order to grip on smaller diameters. This "over the shoulder" feature offers second-op advantages over traditional spring collets.

ROYAL QUICK-GRIP™ CNC COLLET CHUCKS



Big Benefit #4 Slash Cycle Times and Boost Throughput

Royal Quick-Grip™ Offers Unmatched Grip Force and Rigidity

The parallel-grip functionality of Royal Quick-Grip™ Collets provides extremely high grip force by maintaining workpiece contact over the entire length of each collet segment (see image on previous page). Additionally, the design and construction of all Royal Quick-Grip™ CNC Collet Chucks has been optimized for rock-solid rigidity.

This combination of tremendous grip force and outstanding rigidity results in something that every manufacturer strives for – the ability to **drastically increase speeds, feeds and depth of cut**, without sacrificing part accuracy or surface finish.

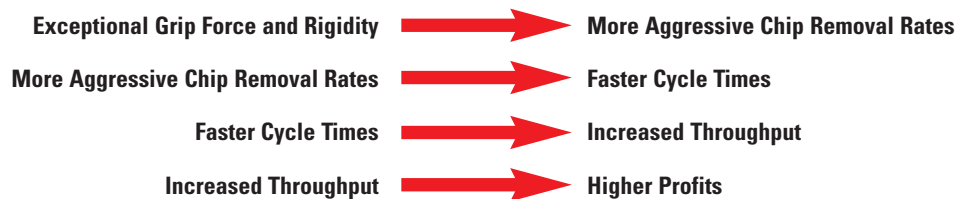

Many Royal Quick-Grip™ users have told us that they have made back their investment in just a few short weeks thanks to such a significant increase in throughput over their previous three-jaw chucks and older-style collet chucks.

Big Benefit #5 Most Compact Collet Chucks in the Industry

Royal Accu-Length™ CNC Collet Chucks have been optimized for tool clearance and rigidity. Short lengths **maximize the usable space inside the machining envelope**, while extremely compact nose diameters reduce tool interference and enable machining to take place closer to the spindle.

Compact
(Standard Length/Compact Nose Diameter)

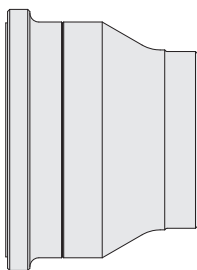

The traditional length ensures that these chucks can accommodate most machine drawtubes, while a greatly reduced nose diameter offers the **best tool clearance in the industry**.

Ultra-Compact
(Compact Length/Compact Nose Diameter)

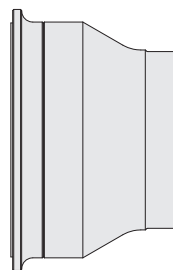

These are the smallest collet chucks available. Often mounted on sub-spindles, Royal's Ultra-Compact CNC Collet Chucks make a great choice when maximum z-axis capacity is the primary requirement.

Extended-Length
(Longer Length/Compact Nose Diameter)

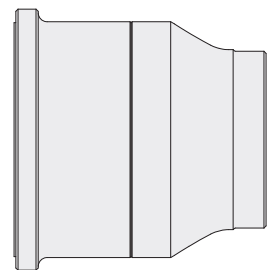

Royal stocks a few chuck models in extended-length versions to accommodate a handful of machines with limited z-axis travel. As a rule, it is usually best to choose the shortest chuck model possible for your machine.



ROYAL QUICK-GRIP™ CNC COLLET CHUCKS

Big Benefit #6

Exclusive Royal Bolt & Go™ Mounting Advantage

All Royal CNC Collet Chucks mount quickly, easily, and accurately due to our exclusive Bolt & Go™ mounting interface.

Many Royal chuck models mount directly to the lathe spindle without the need for an adapter plate. However, for models that do use a plate, a precision-ground tapered fit between the plate's male pilot and chuck body's female recess **ensures a consistent, near-perfect fit without the need for any adjustment**. This precision fit also enhances overall system rigidity by providing both face and taper contact.

Other chuck manufacturers use a less precise approach. Instead of providing a near-perfect tapered interface between the chuck body and plate, they rely on a loose fit between a male cylindrical pilot on the plate and an oversized bore within the chuck body. Because there is clearance between these two components, jack screws located around the circumference must be used to radially true-up the chuck on the plate. This process of using the jack screws and an indicator to dial out the runout each time a chuck is mounted wastes valuable production time. The rigidity of this design is also significantly less due to the limited point-contact provided by the screws against the pilot as compared to the full-contact tapered fit of the Royal Bolt & Go™ interface.

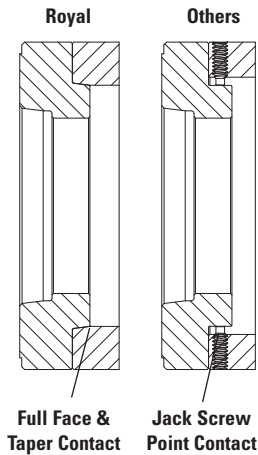

Knock 30 Minutes Off Your Setup Time with Royal Bolt & Go™

Big Benefit #7

Risk-Free Performance Guarantee

- ✓ Smarter Design
- ✓ Better Quality
- ✓ Outstanding Support

**Risk-Free
PERFORMANCE
Guarantee**

- ✓ Same-Day Shipping
- ✓ No Hassles
- ✓ Risk-Free Guarantee

In addition to providing superior quality, service, support, and deliveries, Royal CNC Collet Chucks also carry an industry exclusive risk-free performance guarantee. This no-risk guarantee allows our customers to run a collet chuck on the toughest jobs in their shop for 45-days, and if they are not 100% satisfied with its performance, we will take it back and arrange for a full refund through their distributor.

When you buy a CNC collet chuck from Royal Products, you can have **complete confidence** that we will not let you down. For over 75 years, Royal has been recognized as one of the most reliable and trusted suppliers in the metalworking industry. We are here for you today, and we'll be here for you tomorrow.

ROYAL QUICK-GRIP™ CNC COLLET CHUCKS



Big Benefit #8

Precision-Made in USA

ISO 9001:2015 Certified

- Every Royal CNC collet chuck is completely manufactured in our modern factory on state-of-the-art automated CNC equipment.
- All chucks, sleeves, adapter plates, collets, etc., come off of our gantry-loaded multi-tasking machines complete – eliminating the accuracy and quality issues often associated with multiple setups/operations.
- All grinding takes place on precision Swiss-made CNC grinders that enable multiple features to be ground in a single setup, resulting in near-perfect tolerances and **ensuring absolute consistency from part to part.**
- Royal Products is an ISO9001:2015 registered company dedicated to continuous improvement. Every process is documented and followed down to the smallest detail for consistent quality – every time.



Big Benefit #9

Outstanding Support



Royal maintains a fleet of fully-equipped mobile showrooms designed to bring solutions to our customers' doorsteps. To schedule a visit to your company, please call 1-800-645-4174.

- Royal's knowledgeable team of applications engineers makes it very easy for you to do business with us. When you call Royal, the person you speak with will be a workholding expert, and if we can't offer you the best solution for your application, we'll do our best to recommend a company that can – even if it's a competitor!
- Royal CNC Collet Chucks are sold through a **select network of the country's top industrial and machine tool distributors.** We also have strong relationships with all of the major machine tool builders and importers to make sure that our products seamlessly interface with their machines.
- With over forty factory-trained account managers strategically located throughout North America, our highly-qualified field support team is always ready and willing to serve you.

Big Benefit #10

We Make it Easy

- All Royal CNC collet chucks include everything needed for installation, (even the hex keys). We strive to give our customers **"the mint on the pillow"** treatment.
- Through the past thirty years of gathering machine tool specifications and working closely with all of the major machine tool builders, Royal Products has developed a huge database of drawtube specifications, virtually eliminating the need for a customer to ever measure a machine.
- **We now stock over 375 of the most common drawtube connector models,** and non-stock connectors are made very quickly from semi-finished blanks.
- All Royal CNC collet chucks come packaged in specially designed heavy-gage boxes with form-fitting foam inserts to provide complete protection of all contents.





ROYAL QUICK-GRIP™ ACCU-LENGTH™ CNC COLLET CHUCKS

Bolt & Go™

Our exclusive Bolt & Go™ mounting feature is standard on all Royal Quick-Grip™ Collet Chuck models. **Bolt & Go™ enables chucks to be mounted very quickly and ensures maximum accuracy and rigidity.** See page 10 for additional information.

Completely Sealed

Lubricated for life, these chucks incorporate multiple O-ring seals to keep contaminants out and prevent chip pack-up on bore-thru applications.

High RPM

All Royal Quick-Grip™ Collet Chucks are balanced by design for high-speed operation, and can often be run at higher speeds than conventional 3-jaw chucks because they are less affected by centrifugal force.



Extremely Fast Collet Changes

Changing collets on a Royal Quick-Grip™ CNC Collet Chuck takes just a few seconds. A unique hook and groove design for securing collets is used instead of traditional threads.

Wide Gripping Range

Royal Quick-Grip™ Collets have a 0.062" gripping range (+/- 0.031"), enabling them to accommodate undersized and oversized bar stock. This range is even larger for the QG-100 – 0.080"

High Accuracy

Royal Quick-Grip™ CNC Collet Chucks are very accurate – runout on the closing angle is **guaranteed to be within 0.0002" TIR.**

Low-Profile

Royal Quick-Grip™ CNC Collet Chucks have smaller nose diameters than other quick-change collet chucks for superior tool clearance.

Collet Compatibility

Royal Quick-Grip™ Collet Chucks can sometimes utilize other brands of quick-change collets. Call Royal to verify.

Heavy-Duty Construction

All chuck components, except for the drawtube connector, are hardened to Rc 61-63 for high rigidity and durability.

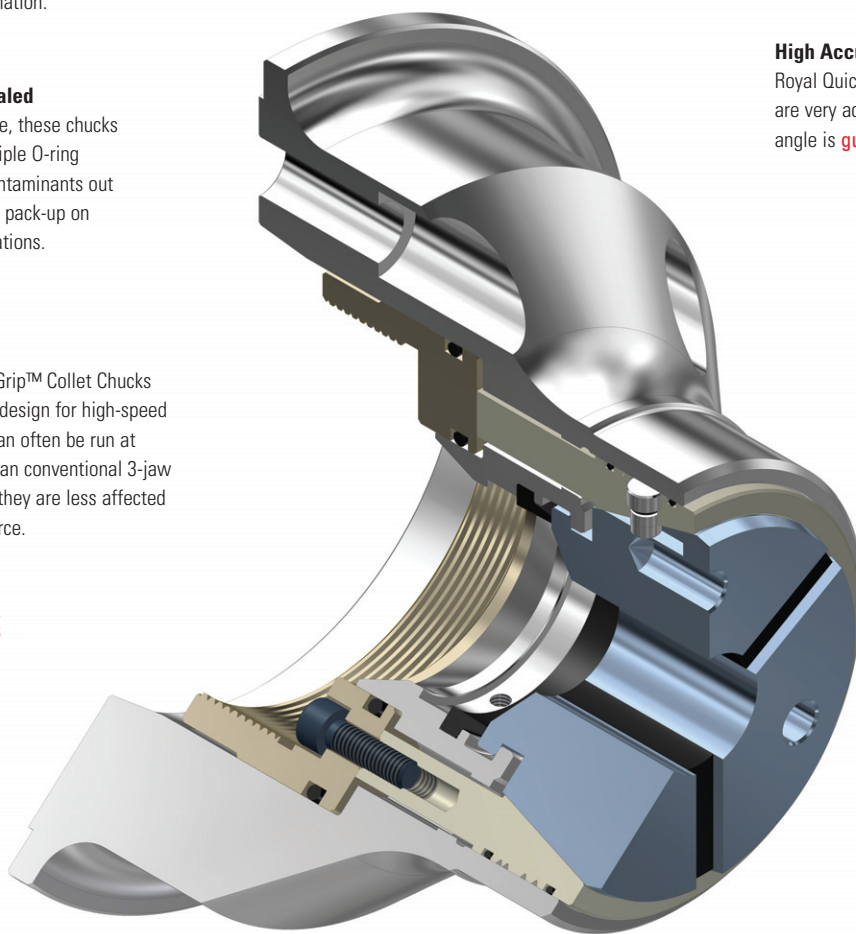

Coolant Slinger

All bodies incorporate an oversized flange to protect the machine tool spindle bearings from coolant penetration.

Shortest Length

Royal Quick-Grip™ CNC Collet Chucks are among **the shortest chucks available**, providing maximum work envelope utilization. This is especially important for smaller machines with limited z-axis travel.

Dead-Length Operation

Royal Quick-Grip™ Accu-Length™ CNC Collet Chucks incorporate dead length operation to eliminate part pullback. With this design, the collet is held stationary in the chuck body and a tapered sleeve pushes forward to compress it, resulting in precise z-axis workpiece positioning.

Easy Installation

Royal Quick-Grip™ Collet Chucks include all mounting hardware, mounting wrenches, and a custom-machined drawtube connector to ensure hassle-free installation.

Specials

If you have a special application that goes beyond the scope of our standard line, we will be happy to design and build a custom system to meet your needs. Please contact a Royal applications engineer to discuss your requirements.

Note – Collets and installation tool sold separately

ROYAL QUICK-GRIP™ ACCU-LENGTH™ CNC COLLET CHUCKS

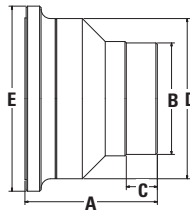

- ✓ 10-second collet changes.
- ✓ Widest collet gripping range – 0.062" (0.080" for QG-100).
- ✓ Extremely accurate – 0.0002" TIR.
- ✓ Parallel workpiece gripping.
- ✓ Compact and ultra-compact models to suit all machines and applications.
- ✓ In-stock for same-day shipping.



Royal Quick-Grip™ Accu-Length™ CNC Collet Chucks

SPINDLE TYPE	COLLET TYPE	MAX CAPACITY		CHUCK STYLE	A OVERALL LENGTH	B NOSE DIAMETER	C NOSE LENGTH	D BODY DIAMETER	E FLANGE DIAMETER	CHUCK WEIGHT (lbs.)	MAX DRAWBAR FORCE (lbs.)	MAX CLAMPING FORCE (lbs.)	MAX RPM	PART NUMBER	PRICE ¹
		BAR	SLUG ³												
A2-5	QG-42	1.66	2.62	C	4.60	4.00	0.75	5.70	6.45	19	7,865	17,980	6,000	46100	\$4,390
A2-5	QG-42	1.66	2.62	UC	4.00	4.00	0.75	5.70	6.45	15	7,865	17,980	6,000	46105	4,390
A2-6	QG-42	1.66	2.62	UC	4.45	4.00	0.75	6.20	7.25	21	7,865	17,980	6,000	46110	4,390
140 MM	QG-42	1.66	2.62	UC	3.95	4.00	0.75	5.70	5.70	15	7,865	17,980	6,000	46115	4,390
A2-5	QG-52	2.03	2.57	C	4.80	4.36	0.75	6.10	6.85	24	7,865	17,980	6,000	46116	4,390
A2-5	QG-52	2.03	2.57	UC	4.20	4.36	0.75	6.10	6.10	18	7,865	17,980	6,000	46117	4,390
A2-6	QG-52	2.03	2.57	UC	4.60	4.36	0.75	6.20	7.25	23	7,865	17,980	6,000	46118	4,390
110 MM	QG-52	2.03	2.57	UC	4.20	4.36	0.75	6.10	6.10	17	7,865	17,980	6,000	46121	4,390
140 MM	QG-52	2.03	2.57	UC	4.20	4.36	0.75	6.10	6.10	19	7,865	17,980	6,000	46119	4,390
A2-5	QG-65	2.66	3.40	C	4.80	4.91	0.87	6.55	7.25	27	10,115	23,600	6,000	46120	4,970
A2-5	QG-65	2.66	3.40	UC	4.50	4.91	0.87	6.55	6.55	24	10,115	23,600	6,000	46125	4,970
A2-6	QG-65	2.66	3.40	C	5.33	4.91	0.87	6.55	7.25	31	10,115	23,600	6,000	46130	4,970
A2-6	QG-65	2.66	3.40	UC	4.65	4.91	0.87	6.55	7.25	24	10,115	23,600	6,000	46135	4,970
A2-6	QG-65	2.66	3.40	EL ²	7.00	4.91	0.87	6.55	7.25	45	10,115	23,600	6,000	46140	4,970
A2-8	QG-65	2.66	3.40	C	5.50	4.91	0.87	8.00	9.45	45	10,115	23,600	6,000	46145	5,590
110 MM	QG-65	2.66	3.40	UC	4.45	4.91	0.87	6.55	6.55	25	10,115	23,600	6,000	46150	5,430
140 MM	QG-65	2.66	3.40	UC	4.80	4.91	0.87	6.55	7.45	29	10,115	23,600	6,000	46155	5,430
A2-5	QG-80	3.28	4.00	C	4.95	5.63	0.87	7.45	7.45	33	11,240	25,850	5,000	46160	5,770
A2-6	QG-80	3.28	4.00	C	4.95	5.63	0.87	7.45	7.45	35	11,240	25,850	5,000	46165	5,770
A2-6	QG-80	3.28	4.00	EL ²	7.00	5.63	0.87	7.45	7.45	58	11,240	25,850	5,000	46166	5,770
A2-8	QG-80	3.28	4.00	C	5.20	5.63	0.87	8.00	9.45	43	11,240	25,850	5,000	46170	5,770
140 MM	QG-80	3.28	4.00	C	4.75	5.63	0.87	7.45	7.45	34	11,240	25,850	5,000	46175	5,770
A2-6	QG-100	4.03	5.15	C	6.18	7.00	0.87	9.40	9.40	76	14,610	33,720	5,000	46180	8,350
A2-8	QG-100	4.03	5.15	C	6.43	7.00	0.87	9.40	10.75	89	14,610	33,720	5,000	46185	8,460
A2-11	QG-100	4.03	5.15	C	6.68	7.00	0.87	9.40	12.50	93	14,610	33,720	5,000	46190	9,890

¹ Includes drawtube connector. Collets and installation tool sold separately.

² Extended-length – for use on machines where z-axis turret travel is limited.

³ Slug capacity requires counterboring of collets. See page 38 details.

C=Compact, UC=Ultra-Compact, EL=Extended-Length



ROYAL QUICK-GRIP™ PULL-TO-A-STOP CNC COLLET CHUCKS

Bolt & Go™

Our exclusive Bolt & Go™ mounting feature is standard on all Royal Quick-Grip™ Collet Chuck models. **Bolt & Go™ enables chucks to be mounted very quickly and ensures maximum accuracy and rigidity.** See page 10 for additional information.

Completely Sealed

Lubricated for life, these chucks incorporate multiple O-ring seals to keep contaminants out and prevent chip pack-up on bore-thru applications.

High RPM

All Royal Quick-Grip™ Collet Chucks are balanced by design for high-speed operation, and can often be run at higher speeds than conventional 3-jaw chucks because they are less affected by centrifugal force.



Coolant Slinger

All bodies incorporate an oversized flange to protect the machine tool spindle bearings from coolant penetration.

Shortest Length

Royal Quick-Grip™ CNC Collet Chucks are among **the shortest chucks available**, providing maximum work envelope utilization. This is especially important for smaller machines with limited z-axis travel.

Note – Collets and installation tool sold separately

Extremely Fast Collet Changes

Changing collets on a Royal Quick-Grip™ CNC Collet Chuck takes just a few seconds. A unique hook and groove design for securing collets is used instead of traditional threads.

Wide Gripping Range

Royal Quick-Grip™ Collets have a 0.062" gripping range (+/- 0.031"), enabling them to accommodate undersized and oversized bar stock. This range is even larger for the QG-100 – 0.080".

High Accuracy

Royal Quick-Grip™ CNC Collet Chucks are very accurate – runout on the closing angle is **guaranteed to be within 0.0002" TIR.**

Low-Profile

Royal Quick-Grip™ CNC Collet Chucks have smaller nose diameters than other quick-change collet chucks for superior tool clearance.

Collet Compatibility

Royal Quick-Grip™ Collet Chucks can sometimes utilize other brands of quick-change collets. Call Royal to verify.

Heavy-Duty Construction

All chuck components, except for the drawtube connector, are hardened to Rc 61-63 for high rigidity and durability.

Easy Installation

Royal Quick-Grip™ Collet Chucks include all mounting hardware, mounting wrenches, and a custom-machined drawtube connector to ensure hassle-free installation.

Specials

If you have a special application that goes beyond the scope of our standard line, we will be happy to design and build a custom system to meet your needs. Please contact a Royal applications engineer to discuss your requirements.

Two-Chucks In One

The Royal Quick-Grip™ Pull-to-a-Stop CNC Collet Chuck includes a removable stop for precise, consistent workpiece positioning. The pullback action of the collet draws the workpiece securely against the stop, eliminating any chance of z-axis part movement and enabling very aggressive cutting.

When thru-hole capacity is required for bar feeding applications, simply remove the stop and the chuck will function as a normal pullback-style collet chuck.

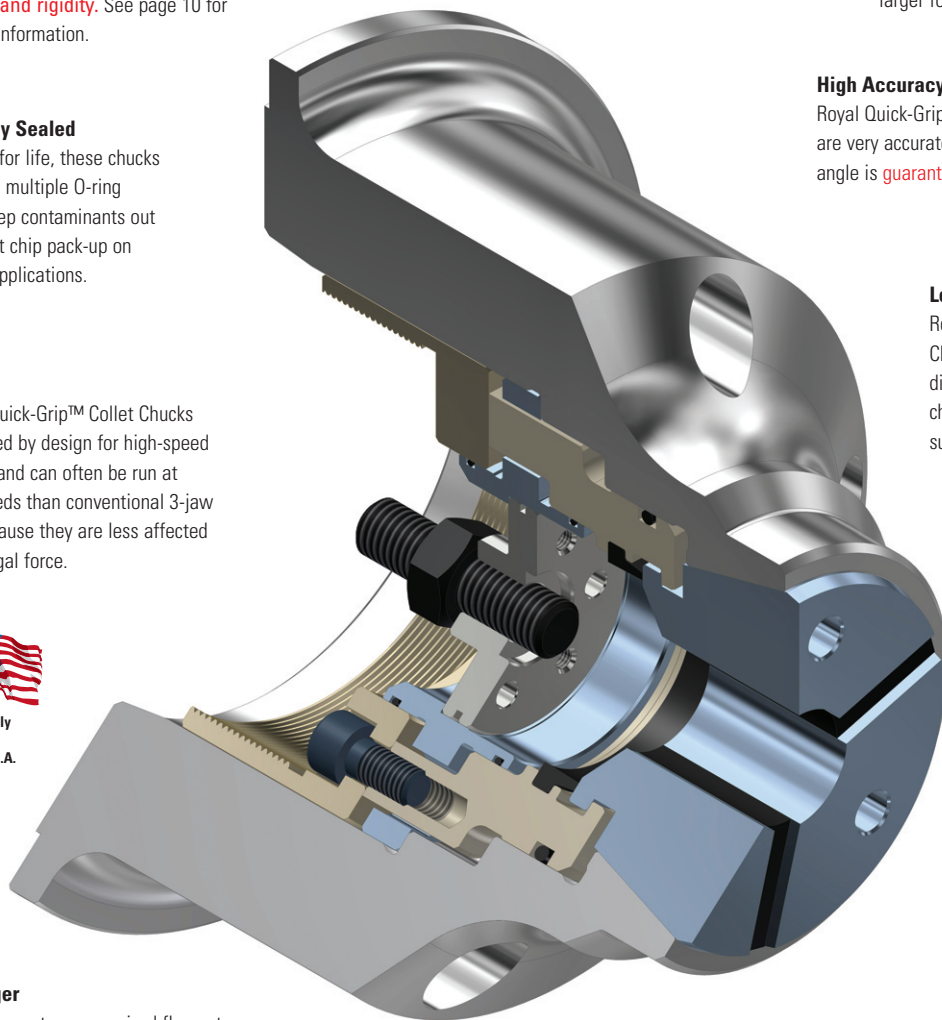

ROYAL QUICK-GRIP™ PULL-TO-A-STOP CNC COLLET CHUCKS



Chuck includes removable standard stop.

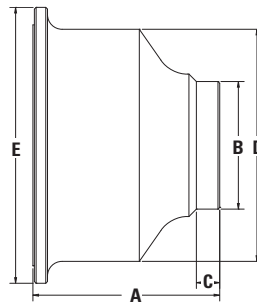

- ✓ Same great features as our Accu-Length™ Quick-Grip™ models, except that the collet is not fixed – it moves axially upon opening and closing.
- ✓ Adjustable stop guarantees precise, consistent z-axis part positioning and enables very aggressive cutting.
- ✓ Ideal for high-volume, robot-load applications in which the part needs to **locate against a shoulder and air-sensing / position confirmation is required.**
- ✓ Also a great choice for any CNC lathe equipped with a servo-driven bar feeder – simply remove the included stop for full thru-capacity.
- ✓ In-stock for same-day shipping.



Royal Quick-Grip™ Pull-to-a-Stop CNC Collet Chucks

SPINDLE TYPE	COLLET TYPE	MAX CAPACITY		A OVERALL LENGTH	B NOSE DIAMETER	C NOSE LENGTH	D BODY DIAMETER	E FLANGE DIAMETER	CHUCK WEIGHT (lbs.)	MAX DRAWBAR FORCE (lbs.)	MAX CLAMPING FORCE (lbs.)	MAX RPM	PART NUMBER	PRICE ¹
		BAR	SLUG ³											
A2-5	QG-42	1.66	2.62	5.10	3.54	0.62	6.00	6.70	21	7,865	17,980	6,000	46010	\$4,690
A2-6	QG-42	1.66	2.62	5.50	3.54	0.62	6.25	7.45	25	7,865	17,980	6,000	46012	4,690
A2-5	QG-52	2.03	2.57	5.25	3.63	0.62	6.19	6.95	21	7,865	17,980	6,000	46028	4,690
A2-6	QG-52	2.03	2.57	5.65	3.63	0.67	6.19	7.25	22	7,865	17,980	6,000	46030	4,690
A2-5	QG-65	2.66	3.40	5.50	4.37	0.80	6.70	7.62	28	10,115	23,600	6,000	46014	5,360
A2-6	QG-65	2.66	3.40	6.00	4.37	0.80	6.70	7.62	29	10,115	23,600	6,000	46016	5,360
A2-6	QG-65	2.66	3.40	7.00 ²	4.37	0.80	6.70	7.62	35	10,115	23,600	6,000	46017	5,360
A2-8	QG-65	2.66	3.40	6.40	4.37	0.80	7.95	9.45	45	10,115	23,600	6,000	46018	5,360
A2-6	QG-80	3.28	4.00	6.00	4.96	0.80	8.00	8.75	44	11,240	25,850	5,000	46020	5,890
A2-8	QG-80	3.28	4.00	6.40	4.96	0.80	8.00	9.45	47	11,240	25,850	5,000	46022	5,890
A2-6	QG-100	4.03	5.15	7.08	6.30	0.80	9.40	9.40	88	14,610	33,720	5,000	46023	7,030
A2-8	QG-100	4.03	5.15	7.33	6.30	0.80	9.40	10.75	95	14,610	33,720	5,000	46024	7,030
A2-11	QG-100	4.03	5.15	7.58	6.30	0.80	9.40	12.50	102	14,610	33,720	5,000	46026	7,640

¹ Includes drawtube connector. Collets and installation tool sold separately.

² Extended-length – for use on machines where z-axis turret travel is limited.

³ Slug capacity requires counterboring of collets. See page 38 details.



ROYAL QUICK-GRIP™ PULLBACK CNC COLLET CHUCKS

Bolt & Go™

Our exclusive Bolt & Go™ mounting feature is standard on all Royal Quick-Grip™ Collet Chuck models. Bolt & Go™ enables chucks to be mounted very quickly and ensures maximum accuracy and rigidity. See page 10 for additional information.

Completely Sealed

Lubricated for life, these chucks incorporate **multiple O-ring seals to keep contaminants out** and prevent chip pack-up on bore-thru applications.

High RPM

All Royal Quick-Grip™ Collet Chucks are balanced by design for high-speed operation, and can often be run at higher speeds than conventional 3-jaw chucks because they are less affected by centrifugal force.

Coolant Slinger

All bodies incorporate an oversized flange to protect the machine tool spindle bearings from coolant penetration.

Shortest Length

Royal Quick-Grip™ CNC Collet Chucks are among the shortest chucks available, providing maximum work envelope utilization. This is especially important for smaller machines with limited z-axis travel.

Specials

If you have a special application that goes beyond the scope of our standard line, we will be happy to design and build a custom system to meet your needs. Please contact a Royal applications engineer to discuss your requirements.

Extremely Fast Collet Changes

Changing collets on a Royal Quick-Grip™ CNC Collet Chuck takes just a few seconds. A unique hook and groove design for securing collets is used instead of traditional threads.

Wide Gripping Range

Royal Quick-Grip™ Collets have a 0.062" gripping range (+/- 0.031"), enabling them to accommodate undersized and oversized bar stock. This range is even larger for the QG-100 – 0.080".

High Accuracy

Royal Quick-Grip™ CNC Collet Chucks are very accurate – runout on the closing angle is guaranteed to be within 0.0002" TIR.

Low-Profile

Royal Quick-Grip™ CNC Collet Chucks have **smaller nose diameters** than other quick-change collet chucks for superior tool clearance.

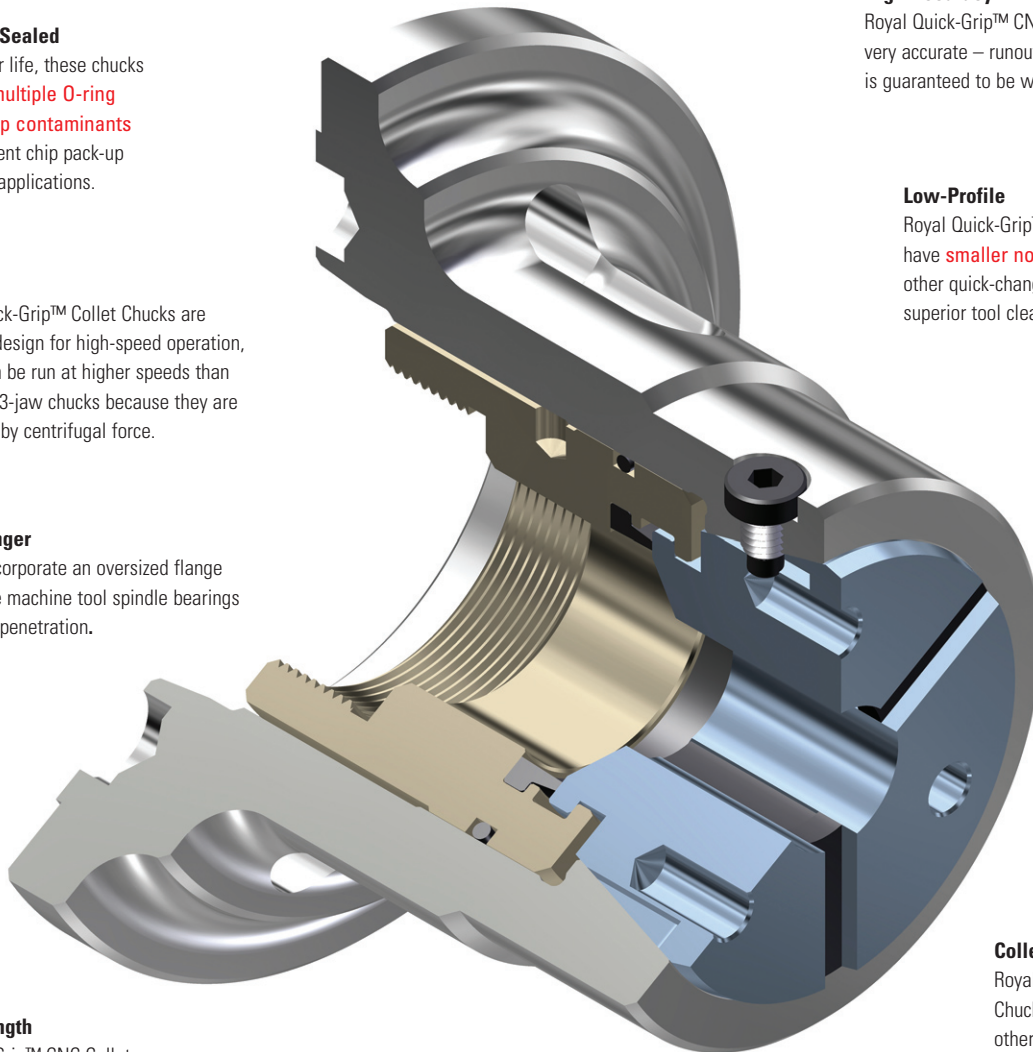

Collet Compatibility

Royal Quick-Grip™ Collet Chucks can sometimes utilize other brands of quick-change collets. Call Royal to verify.

Easy Installation

Royal Quick-Grip™ Collet Chucks include all mounting hardware, mounting wrenches, and a custom-machined drawtube connector to ensure hassle-free installation.

Heavy-Duty Construction

All chuck components, including the drawtube connector, are **hardened to Rc 61-63 for high rigidity and durability.**

Note – Collets and installation tool sold separately

ROYAL QUICK-GRIP™ PULLBACK CNC COLLET CHUCKS



- ✓ Traditional pullback design – collet is pulled into chuck to close, pushed out to open.
- ✓ No collet stop capability, therefore this chuck style is **typically used only on jobs where holding precise axial position is not critical.**
- ✓ Includes many of the same features of our QG Accu-Length™ models, including:
 - 10-second collet changes
 - 0.0002" TIR accuracy on closing angle
 - Wide 0.062" collet range (0.080" for QG-100)
 - Compact dimensions for superior clearance
- ✓ In-stock for same-day shipping.

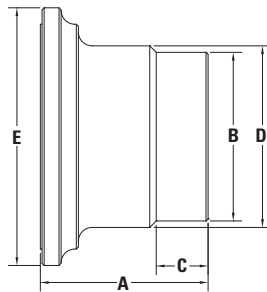

Royal Quick-Grip™ Pullback CNC Collet Chucks



SPINDLE TYPE	COLLET TYPE	MAX CAPACITY		A OVERALL LENGTH	B NOSE DIAMETER	C NOSE LENGTH	D BODY DIAMETER	E FLANGE DIAMETER	CHUCK WEIGHT (lbs.)	MAX DRAWBAR FORCE (lbs.)	MAX CLAMPING FORCE (lbs.)	MAX RPM	PART NUMBER	PRICE ¹
		BAR	SLUG ²											
A2-5	QG-42	1.66	2.62	4.45	4.11	3.50	5.25	6.45	11	7,865	17,980	6,000	44020	\$2,770
A2-6	QG-42	1.66	2.62	4.35	4.11	1.50	4.38	7.45	13	7,865	17,980	6,000	44022	2,960
A2-5	QG-65	2.66	3.40	4.30	4.88	1.50	6.45	6.45	19	10,115	23,600	6,000	44028	3,160
A2-6	QG-65	2.66	3.40	4.85	4.88	1.50	5.25	7.45	17	10,115	23,600	6,000	44030	3,160
A2-8	QG-65	2.66	3.40	5.00	4.88	1.50	5.72	9.45	25	10,115	23,600	6,000	44032	3,890
A2-6	QG-80	3.28	4.00	4.85	5.47	1.25	5.68	7.45	25	11,240	25,850	5,000	44034	3,980
A2-8	QG-80	3.28	4.00	5.00	5.47	1.25	5.72	9.45	25	11,240	25,850	5,000	44036	3,980

¹ Includes drawtube connector. Collets and installation tool sold separately.

² Slug capacity requires counterboring of collets. See page 38 details.



Check out the Royal Quick-Grip™ CNC Collet Chuck Video at www.colletchucks.com



ROYAL QUICK-GRIP™ POWER-BLOCK™ COLLET FIXTURES

Hydraulic or Pneumatic Actuation

Extremely Fast Collet Changes

Changing collets on a Royal Quick-Grip™ Power-Block™ takes just a few seconds. A unique hook and groove design for securing collets is used instead of traditional threads.

Wide Gripping Range

Royal Quick-Grip™ Collets have a 0.062" gripping range (+/- 0.031"), enabling them to accommodate undersized and oversized bar stock. This range is even larger for the QG-100 – 0.080".

Flexible

The face of the Royal Power-Block™ is precision-ground and **includes tapped holes, enabling the use of custom stops, locators, etc.**

Heavy-Duty Construction

Body and piston are hardened to Rc 61-63 for maximum rigidity and durability.

Low Maintenance

Oversized evacuation slots on all four sides enable chips to be easily flushed clear on bore-thru applications.

Tool Clearance Optimized

Slim nose diameter offers **better tool clearance compared to vises and other prismatic workholding devices.**

Extreme Grip Force

The gripping segments of Royal Quick-Grip™ collets always remain parallel to the workpiece over their full length, ensuring grip force is evenly distributed. This is a **significant advantage for thin-walled parts that are susceptible to crushing.**

Completely Sealed

Lubricated for life, these fixtures incorporate multiple O-ring seals to prevent chips and coolant from impacting piston movement.

Great for 5th-Axis Applications!

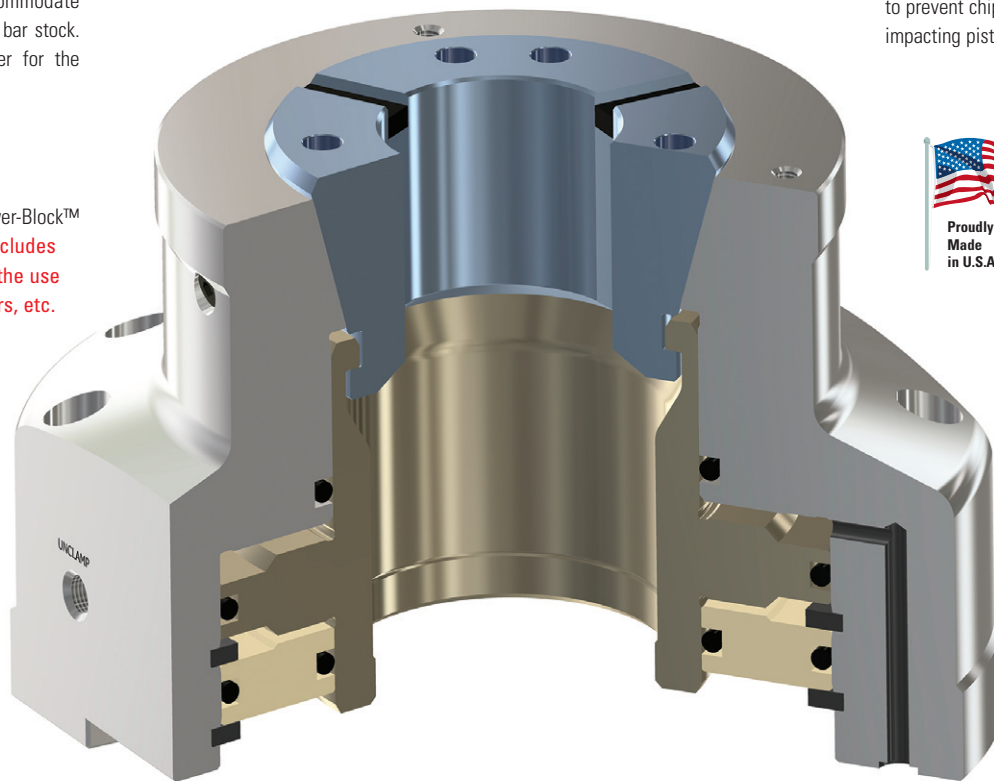

Dual-Port Actuation

All units are equipped with ports on both the side and bottom surface of the fixture, offering **actuation flexibility for both fixed and rotary table applications.**

Custom Collet Profiles

One of the greatest advantages of this workholding system is in Royal's ability to supply custom collet profiles for odd-shaped second-op gripping. See examples on page 39.

Precision Mounting

Internal bore and external OD are both precision-ground, offering flexibility while **ensuring accurate, repeatable mounting to plates, tombstones, etc.**



Note – Collets and installation tool sold separately

ROYAL QUICK-GRIP™ POWER-BLOCK™ COLLET FIXTURES

Hydraulic or Pneumatic Actuation



- Royal Power-Block™ Collet Fixtures bring the full functionality of our Quick-Grip™ CNC Collet Chucks to your vertical and horizontal machining centers.
- These fixtures incorporate many of the same great features as our Quick-Grip™ CNC Collet Chucks, including ten-second collet changes and the use of parallel-grip collets with a full 0.062" clamping range (0.080" for QG-100).
- **A great alternative to traditional vises and fixtures** – especially for long, thin parts, or those with asymmetrical external features.
- Units are designed to be actuated via hydraulic pressure, and may also be actuated pneumatically for lighter-duty applications (contact Royal for details).
- Engineered for use in both stationary and rotary-table applications. **Caution – not for use on lathes or grinders above 60 rpm!**
- Heavy-duty all steel construction with a large double-acting piston for high clamping force.
- Configured with both side and bottom ports for plumbing flexibility.
- Multiple units can be plumbed in series for single-source actuation.
- Mounting face is precision-ground for perpendicularity to centerline.
- **Ideal for high-production vertical and horizontal milling applications.**
- For use with Royal Quick-Grip™ collets and installation tools (pages 24-40).

When paired with a custom-profile Quick-Grip™ collet, the Royal Power-Block™ can help you optimize your workholding for parts that aren't well-suited to traditional vises or prismatic fixtures. See page 39 for examples.

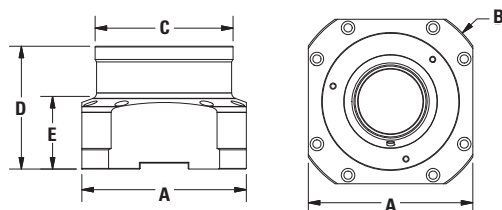

Power-Block™ Grip Force Specifications*

MODEL	MAX INPUT HYDRAULIC PRESSURE (psi.)	MAX AXIAL FORCE (lbs.)	MAX CLAMPING FORCE (lbs.)
QG-42	580	7,865	17,980
QG-52	580	7,865	17,980
QG-65	580	10,115	23,600
QG-80	580	11,240	25,850
QG-100	580	14,610	33,720

*Contact Royal for pneumatic actuation specifications.

Royal Quick-Grip™ Power-Block™ Collet Fixtures

MODEL	CAPACITY		A (SQUARE)	B (OUTER DIA.)	C	D	E	FIXTURE WEIGHT (lbx.)	PART NUMBER	PRICE*
	(ROUND)	(SQUARE)								
QG-42	1.66	1.16	6.06	6.89	4.92	4.72	3.18	27	43950	\$3,280
QG-52	2.00	1.37	6.06	6.89	4.13	4.72	3.56	25	43962	3,280
QG-65	2.66	1.78	6.85	8.27	4.92	5.12	3.36	33	43964	3,535
QG-80	3.28	2.03	7.34	8.46	6.30	5.12	3.00	38	43954	3,975
QG-100	4.03	2.78	9.02	10.63	8.46	5.51	3.38	66	43956	5,470

*Collets and installation tool sold separately.



ROYAL QUICK-GRIP™ POWER-BLOCK™ RISERS

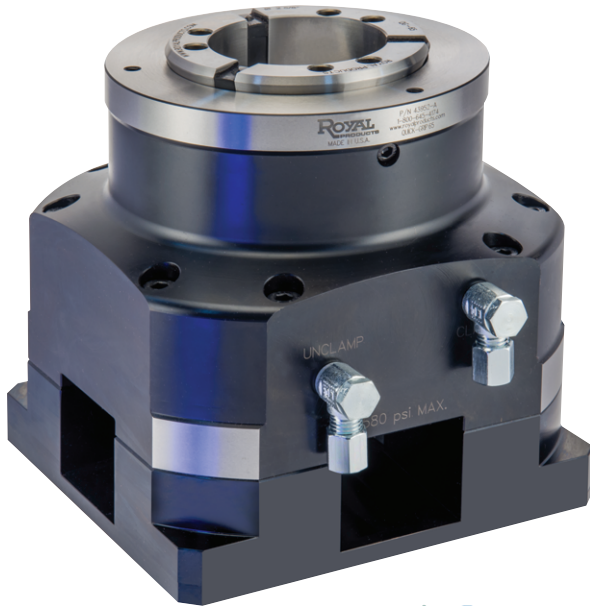

- These risers are designed specifically for Royal Power-Block™ Collet Fixtures and have multiple uses, including:
 - Raising the fixture height for **improved 5th-axis accessibility**.
 - Enhancing chip evacuation for thru-hole machining applications.
- Surface ground within 0.0002" parallelism.
- Manufactured from semi-hard 4140 steel for toughness, yet it is still easily machineable for customization.
- Thickness held within 0.0005" tolerance for accurate interchangeability.
- Tapped center hole enables easy installation of a depth stop.
- 20mm wide keyway on bottom surface provides secure engagement with machining center tables and rotary tables.
- Flexible mounting:
 - Milled flats allow for the use of hold-down clamps.
 - Bolt directly to the machine table.
 - Secure with T-nuts.
- Risers also available for Royal Key-Operated Power-Block™ Fixtures. Please contact one of our applications engineers for information.
- In stock for same-day shipping.

Royal Power-Block™ Risers

FITS HYDRAULIC POWER-BLOCK™ MODEL	A	B	C	PART NUMBER	PRICE*
QG-42	6.06	6.89	1.75	43970	\$1,265
QG-52	6.06	6.89	1.75	43970	1,265
QG-65	6.85	8.27	1.75	43972	1,295
QG-80	7.34	8.46	1.75	43974	1,375
QG-100	9.02	10.63	1.75	43976	1,640

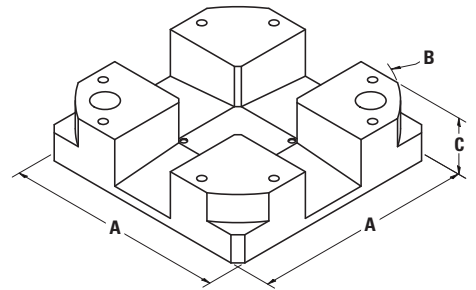

*Rise only. Order Power-Block™ and collets separately.

The Royal Power-Block™ In Action

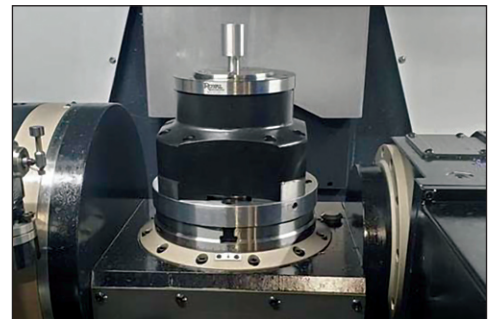
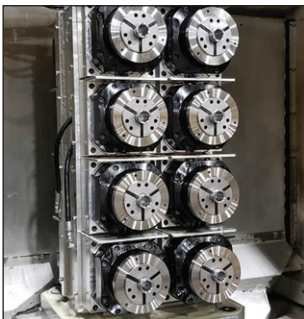

ROYAL CUSTOM POWER-BLOCK™ WORKHOLDING



The Royal Power-Block™ offers unique production-enhancing opportunities for:

- ✓ 5th-Axis Applications
- ✓ Horizontal Machining Centers
- ✓ Multi-Station Rotary-Transfer Applications

Here is a sampling of how some of our customers have greatly improved productivity with Royal Power-Blocks™.

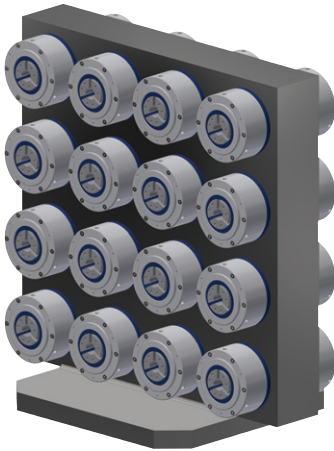

Application: Double-sided shaft-end machining on a horizontal machining center.

Capacity: 16 parts at one time.

Unique Features:

- 32 custom Small-Body Accu-Length™ Collet Fixtures mounted to a custom internally ported T-column.
- Gripping force supplied by internal die springs in each fixture.
- Pneumatically unclamped via a single intake port.
- This arrangement allows for all parts to be loaded and clamped off-line, so when the column travels into the machining center no air or hydraulic lines need to remain attached.

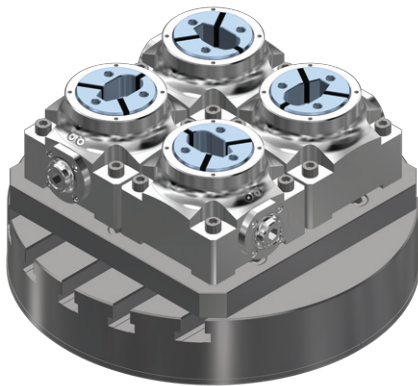

Application: “Tapered Oval” shaped part in a 5th-axis machining center.

Capacity: Four parts at one time.

Unique Features:

- Four standard Key-Operated Power-Blocks™ mounted to the machine tool rotary table via a custom adapter plate.
- Four hardened and ground collets custom-machined according to the exact part profile.
- Customer experienced an increase in throughput of 236% over the multi-station vise that was previously being used.

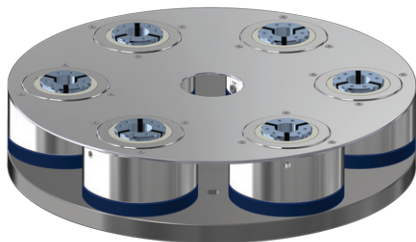

Application: Six-station rotary-transfer machine.

Capacity: Five parts in process at one time. Sixth station used for load/unload.

Unique Features:

- Six custom Small-Body Accu-Length™ Hydraulic Power-Block™ Fixtures mounted to a custom plate.
- Six custom counter-bored collets for precise z-axis positioning.
- Custom chip-shield.
- Clamp/unclamp provided via a centrally located indexing hydraulic manifold (not shown).

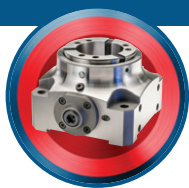

ROYAL QUICK-GRIP™ POWER-BLOCK™ KEY-OPERATED COLLET FIXTURES

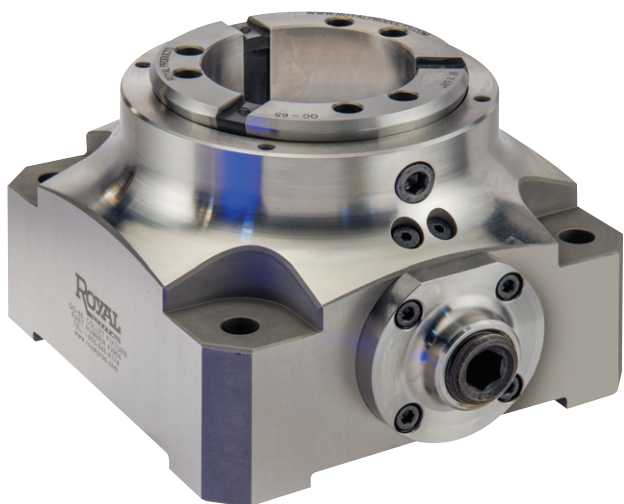

- ❑ Unit is mechanically actuated via an included hex key.
- ❑ Can be used in both stationary and rotary table applications. **Caution – not for use on lathes or grinders above 5 rpm!**
- ❑ Many of the same great features as our Quick-Grip™ CNC Collet Chucks, including ten-second collet changes and parallel-grip collets with a full 0.062" clamping range (0.080" for QG-100).
- ❑ Pullback design with an internally threaded back plate enables the use of a stop rod.
- ❑ Fixture face is precision ground and includes tapped holes, enabling the use of custom stops, locators, etc.
- ❑ Bottom and all four sides are ground for both vertical and horizontal mounting.
- ❑ **Ideal for high production 4th and 5th-axis applications.**
- ❑ For use with Royal Quick-Grip™ collets and installation tools (pages 24-40).

Great for Job Shops!

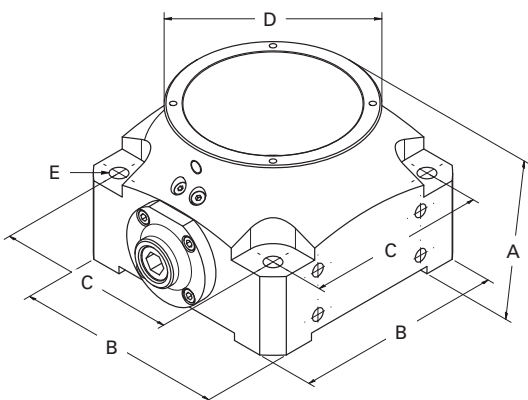

Royal Quick-Grip™ Power-Block™ Key-Operated Collet Fixtures

MODEL	CAPACITY		A	B	C	D	E	MAX TIGHTENING TORQUE (ft.-lbs.)	MAX CLAMPING FORCE (lbs.)	PART NUMBER	PRICE*
	ROUND	SQUARE									
QG-42	1.66"	1.16"	3.94	5.12	3.94	3.94	0.43	42	5,125	43900	\$3,865
QG-52	2.03"	1.41"	3.94	5.12	3.94	3.94	0.43	42	5,125	43902	3,865
QG-65	2.66"	1.78"	3.94	5.91	4.72	4.72	0.43	42	6,430	43904	4,085
QG-80	3.28"	2.03"	4.33	6.50	5.31	5.31	0.51	57	7,420	43908	5,635
QG-100	4.03"	2.78"	4.33	7.87	6.69	6.50	0.51	57	9,375	43912	6,075

*Collets and installation tool sold separately

ROYAL KEY-OPERATED QUICK-GRIP™ COLLET CHUCK FOR MANUAL LATHES

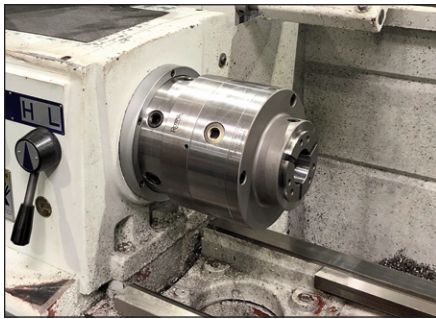
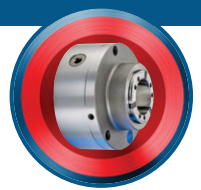

- ❑ Now you can **enjoy the same great features of the Royal Quick-Grip™ CNC Collet Chuck on your manual engine lathes**, including ten-second collet changes and parallel-grip collets with a full 0.062" clamping range.
- ❑ No hydraulic actuator needed – chuck is operated with a traditional square-drive chuck key (included) via a side-access screw.
- ❑ In addition to manual lathe applications, this chuck can also be utilized on indexers, rotary tables, etc.
- ❑ By eliminating the drawtube and offering a full 2-5/8" thru capacity (compared to 1-1/16" of a 5C collet closer), users can **make much better use of their lathe's spindle capacity**.
- ❑ Very accurate – 0.0005" TIR guaranteed!
- ❑ Balanced to 4,000 rpm.
- ❑ Superior gripping force – up to 16,860 lbs.
- ❑ Order backplate separately. Other backplate styles available as custom order.
- ❑ For use with Royal QG-65 collets and installation tools (pages 24-40).
- ❑ Note – this product is **specifically designed for use on manual equipment not equipped with a hydraulic actuator**. For CNC lathes, better performance will be achieved through the use of Royal CNC Collet Chucks.

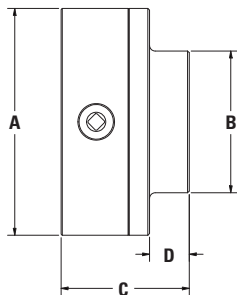

Royal Key-Operated Quick-Grip™ Collet Chuck for Manual Lathes*

MODEL	CAPACITY	A	B	C	D	MAX TIGHTENING TORQUE (ft.-lbs.)	MAX CLAMPING FORCE (lbs.)	PART NUMBER	PRICE
QG-65	2.66	7.87	4.92	4.45	1.38	118	16,860	43920	\$5,405

*Order backplate, collets, and installation tool separately.

Backplates for Key-Operated QG Collet Chuck

MODEL	PLATE DIAMETER	PLATE THICKNESS	PART NUMBER	PRICE
A2-5	7.87	1.10	43930	\$1,089
A2-6	7.87	1.18	43932	1,190
D1-5	7.87	1.60	43934	1,375
D1-6	7.87	1.85	43936	1,665

- ❑ Hardened and precision ground.
- ❑ Backplates accept Royal Quick-Grip™ stops featured on page 24.



ROYAL QUICK-GRIP™ CNC COLLET CHUCK ACCESSORIES

Royal Quick-Grip™ Collet Installation Tools

- Easy to use tools enable collets to be changed in seconds.
 - Simply insert the steel pins into the collet face holes and squeeze the trigger to collapse the collet.
 - Available in both manual and pneumatic versions.
- Note** – pneumatic changing tools require an air supply line.

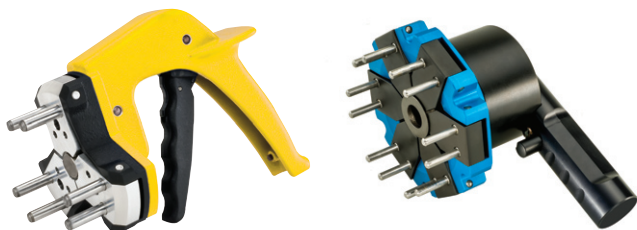

Royal Quick-Grip™ Collet Installation Tools

FITS CHUCK MODEL	TYPE	PART NUMBER	PRICE
QG-42	Manual	44097	\$598
QG-42	Pneumatic	44371	1,505
QG-52	Manual	44095	598
QG-52	Pneumatic	44359	1,365
QG-65	Manual	44098	598
QG-65	Pneumatic	44372	1,505
QG-80	Manual	44099	598
QG-80	Pneumatic	44373	2,575
QG-100	Pneumatic	44374	2,575

Royal Quick-Grip™ Standard and Extra-Depth Stops

- A stop is used for accurate z-axis positioning of short workpieces within a collet.
- Rod length is easily adjusted according to workpiece parameters.
- Royal's easy-to-install stop assemblies locate against a shoulder within the chuck body and are held rigidly in-place with radially-located screws.
- Royal Quick-Grip™ Extra-Depth Stops have a greater throat depth than the standard stops, enabling **longer parts to be swallowed while minimizing protrusion beyond the collet face.**
- For use with Royal Accu-Length™ and Pull-to-a-Stop Quick-Grip™ CNC Collet Chuck Models.

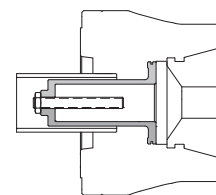

Royal Quick-Grip™ Standard Stops

FITS CHUCK MODEL	MAX THROAT DEPTH*		PART NUMBER	PRICE
	ACCU-LENGTH CHUCK MODELS	PULL-TO-A-STOP CHUCK MODELS		
QG-42	2.03	2.89	44080	\$220
QG-52	2.17	3.04	44818	220
QG-65	2.47	3.33	44081	249
QG-80	2.46	3.33	44084	284
QG-100	2.71	3.65	44816	322

* Measured from collet face.

Royal Quick-Grip™ Extra-Depth Stops

FITS CHUCK MODEL	MAX THROAT DEPTH*		MAX PART DIAMETER	MIN DRAWTUBE I.D.	PART NUMBER	PRICE
	ACCU-LENGTH CHUCK MODELS	PULL-TO-A-STOP CHUCK MODELS				
QG-42	5.00	5.86	1.25	1.66	44802	\$388
QG-52	5.00	5.87	1.38	1.78	44803	388
QG-65	6.00	6.86	1.25	1.66	44804	438
QG-65	6.00	6.86	2.25	2.73	44806	438
QG-80	5.95	6.82	2.00	2.48	44808	529
QG-80	5.95	6.82	2.75	3.23	44810	529
QG-100	6.00	6.94	2.75	3.23	44812	639
QG-100	6.00	6.94	3.50	3.91	44814	639

* Measured from collet face.

ROYAL QUICK-GRIP™ CNC COLLET CHUCK ACCESSORIES



Royal Quick-Grip™ Ejectors

- Ejectors are used in sub-spindle applications with Royal Quick-Grip™ Accu-Length™ CNC Collet Chucks to push finished workpieces into the part catcher upon completion.
- A hardened plunger rod and a bronze bushing work together to provide **smooth, consistent operation**.
- Design enables tip to be changed without removing ejector assembly from the chuck.
- Available in standard and compact models:
 - Standard Model – for parts ranging in size from 0.81" to 4.00" dia.
 - Compact Model – for parts ranging in size from 0.18" to 1.50" dia.
- Easily customizable as workpiece configurations require.
- Pneumatic versions also available upon request.

For an alternative solution to an ejector, check out the Royal Grippex Coolant-Actuated Bar Puller. The Grippex, when fitted with special jaws, can be used to pull finished parts from a sub-spindle, eliminating the need for an ejector and **freeing up the spindle bore to swallow longer parts**.



Royal Quick-Grip™ Ejectors

FITS ACCU-LENGTH™ CHUCK MODEL	EJECTOR STYLE	PART DIAMETER RANGE	PART NUMBER	PRICE
QG-42	Compact	0.18–1.25	44043	\$944
QG-42	Standard	0.81–1.63	44040	1,090
QG-52	Compact	0.18–1.25	44037	944
QG-52	Standard	0.81–2.03	44035	1,090
QG-65	Compact	0.18–1.25	44044	960
QG-65	Standard	0.81–2.63	44041	1,110
QG-80	Compact	0.18–1.25	44045	977
QG-80	Standard	0.81–3.25	44042	1,125
QG-100	Compact	0.50–1.50	44047	996
QG-100	Standard	1.50–4.00	44046	1,145

Royal Hardened and Ground Adapter Plates



- Adapter plates offer the flexibility to mount collet chucks and 3-jaw chucks to a wider range of spindles:
 - Mount a larger chuck on a smaller spindle for increased capacity.
 - Mount a smaller chuck on a larger spindle for increased tool clearance and higher speeds.
- All Royal adapter plates are **hardened to Rc 61-63**.
- High accuracy – 0.0002" TIR guaranteed.
- Metric screws included for mounting plate to spindle.
- Drive button included on all plates.

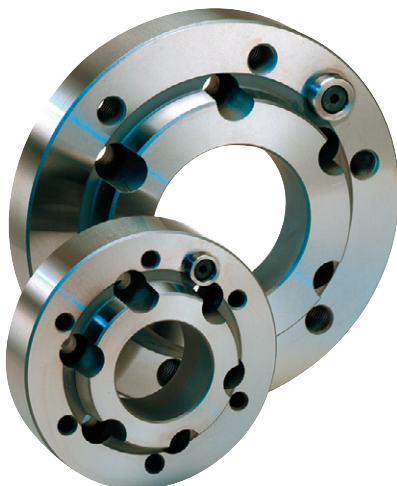

Royal Hardened and Ground Adapter Plates

SPINDLE MOUNT	CHUCK MOUNT	PLATE DIAMETER	PLATE THICKNESS	THRU-HOLE DIA.	SPINDLE MOUNTING BOLTS	CHUCK MOUNT THREADS	PART NUMBER	PRICE
A2-5	A2-6	6.68	1.00	2.63	M-10	M-12	44000	\$1,665
A2-6	A2-6	6.68	1.25	3.56	M-12	M-12	44009	1,485
A2-6	A2-8	8.68	1.00	3.75	M-12	M-16	44004	1,925
A2-8	A2-6	8.25	1.75	3.44	M-16	M-12	44010	1,925
A2-8	A2-8	8.69	2.00	4.76	M-16	M-16	44011	2,025
A2-11	A2-8	11.00	2.00	4.76	M-20	M-16	44014	2,445
110MM	A2-5	5.31	0.75	2.00	M-10	M-10	44006	1,445
140MM	A2-6	6.68	1.00	3.00	M-10	M-12	44008	1,720

Other configurations available. Contact a Royal Products applications engineer at 1-800-645-4174 with your requirements.

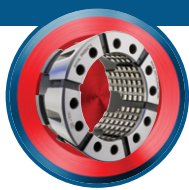

ROYAL ULTRA-PRECISION QUICK-GRIP™ COLLETS

Full Range of Inch and Metric Sizes Available from Stock

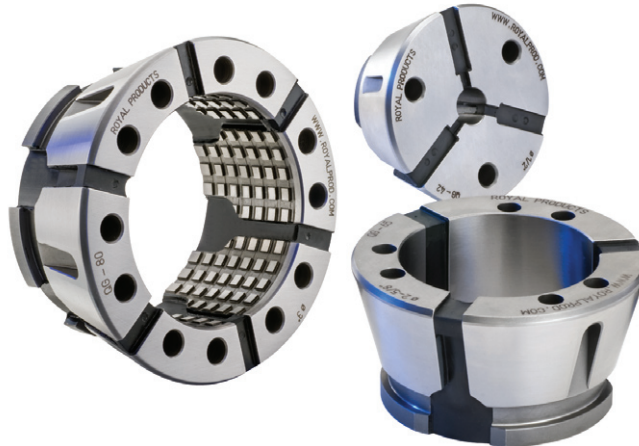

These Extremely Advanced Collets Will Revolutionize Your Workholding

- **Industry-leading 0.062" Gripping Range (0.080" for QG-100)** – greater than other quick-change collets on the market and more than 12X that of traditional spring collets (see page 8).
- Royal Quick-Grip Collets are precision-ground to nominal size, with a gripping range of +/- 0.31" to handle undersized/oversized stock (+/- 0.40" for QG-100).
 - Example** – a ½" QG-65 collet is ground to 0.500" dia., and can hold any part ranging in size from 0.469" – 0.531" dia.
- **Ultra-Precision Accuracy – 0.0002" TIR** or better guaranteed on round-bores (see page 8). Total system accuracy (chuck + collet) guaranteed to 0.0004" or better.
- All Royal Quick-Grip™ Collets are designed for minimal projection beyond the chuck face (≤ 0.020") for optimum rigidity and machine work-zone utilization.
- All models have a smooth gripping surface, but round-bores are also available from stock in a double-serrated version for very aggressive first-op machining.
- Vulcanized rubber between the hardened steel collet segments provides outstanding protection against coolant and chip penetration, and **Royal's advanced vulcanization process carries a lifetime guarantee against failure.**
- Collets can be counter-bored for increased capacity (see page 38).
- S-type master collets available for QG-65 and QG-80 chuck models – see page 40.
- Royal Quick-Grip™ Collets are compatible with some other brands of quick-change chucks, but note that the QG-80 and QG-100 models have a six-slot design (for increased gripping torque) that requires the use of a Royal installation tool. Call us to verify compatibility.
- Custom sizes and shapes available as **quick-ship specials**. Collet segments can also be carbide-coated for extremely harsh applications. Contact one of our applications engineers at 1-800-645-4174 to discuss your requirements.

Royal Ultra-Precision Quick-Grip™ Collet Specifications

COLLET MODEL	COLLET RANGE	NUMBER OF SLOTS	ROUND		HEX	SQUARE	EMERGENCY COLLETS AVAILABLE	CUSTOM SIZES AND SHAPES AVAILABLE	CARBIDE COATING AVAILABLE
			MAXIMUM THRU CAPACITY	MAXIMUM CAPACITY WHEN COUNTER-BORED**	MAXIMUM THRU CAPACITY	MAXIMUM THRU CAPACITY			
QG-42	0.062	3	1.66	2.62	1.40	1.15	Y	Y	Y
QG-52	0.062	3	2.03	2.57	1.78	1.41	Y	Y	Y
QG-65	0.062	3	2.66	3.40	2.28	1.78	Y	Y	Y
QG-80	0.062	6*	3.28	4.00	2.78	2.03	Y	Y	Y
QG-100	0.080	6*	4.03	5.15	3.28	2.78	Y	Y	Y

* The unique six-slot design of the Royal QG-80 and QG-100 Quick-Grip™ collets provides increased workpiece contact over the entire gripping range for superior gripping torque over other brands.

** Counter-boring collets is a special operation and it is important to note that the maximum counter-bore diameter varies with depth. For more information, please see page 38 or contact Royal.

ROYAL ULTRA-PRECISION QUICK-GRIP™ COLLETS

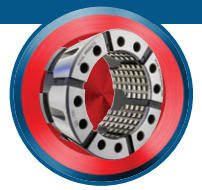

Why Do Top Manufacturers Insist on Royal Quick-Grip™ Collets?

Industry-Leading 0.062" Gripping Range (0.080" for QG-100) Covers More Diameters with Fewer Collets

Ultra-Precision Accuracy – 0.0002" TIR or Better

Vulcanization Guaranteed for Life

Parallel-Grip Maintains Full-Length Part Engagement



Exceptional Grip-Force Enables Very Aggressive Cutting

Exclusive Royal Risk-Free Performance Guarantee

Fast Delivery on Custom Shapes and Sizes – See Page 39

Special Slot Relief Grinding Eliminates "Collet Popping" and Minimizes Chuck Wear

Order Today – Have it Tomorrow

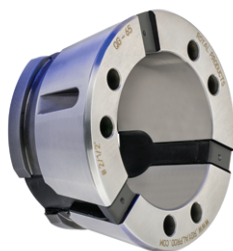

Round – Smooth

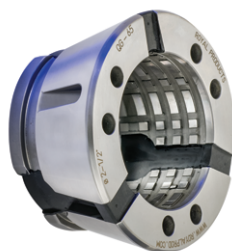

Round – Serrated

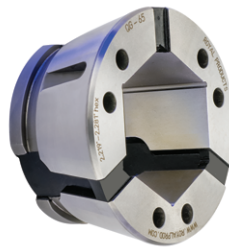

Hex

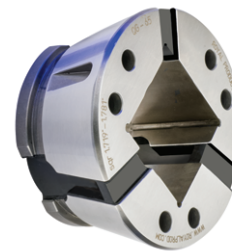

Square

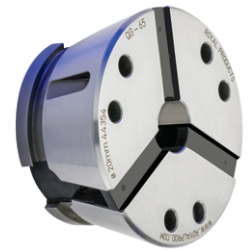

Emergency

**Thousands of Round, Hex, Square and Emergency Collets
IN-STOCK for SAME-DAY SHIPPING!**



ROYAL ULTRA-PRECISION QUICK-GRIP™ COLLETS

QG-42

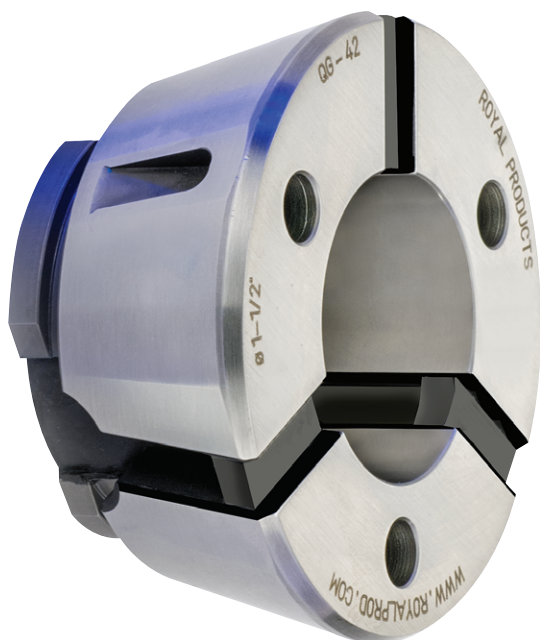

QG-42 CAPACITY

Bar Diameter	1.66" (42.8mm)
Slug Diameter*	2.62" (66.5mm)

* See page 38 for details.

- ❑ Huge inventory of Round, Hex, Square, and Emergency styles always in stock, ready for same-day shipping.
- ❑ Smooth and serrated versions for round-bore models (all others smooth only).
- ❑ **Industry-leading 0.062" gripping range** covers a wide range of part diameters. Collets are ground to nominal size and have a range of +/- 0.031".
- ❑ Parallel-grip ensures full-length part contact for maximum grip force, rigidity, and accuracy.
- ❑ Can be counter-bored for increased part capacity up to 2.62" – see page 38 for details.
- ❑ Quick-ship specials available for custom shapes.
- ❑ Can utilize manual and pneumatic changing tools.

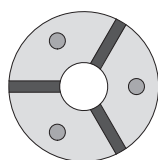

Round Inch

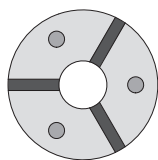

Round Metric

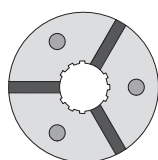

Serrated

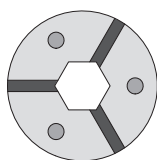

Hex

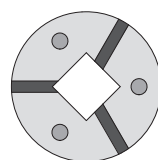

Square

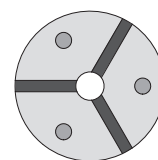

Emergency

Royal QG-42 **Round** Collets (Inch) – \$297 Each

NOMINAL SIZE	RANGE (INCHES)	SMOOTH PART NUMBER	SERRATED PART NUMBER
3/16"	0.157–0.219	44101	N/A
7/32"	0.188–0.250	44102	N/A
1/4"	0.219–0.281	44103	N/A
9/32"	0.250–0.312	44104	N/A
5/16"	0.282–0.344	44105	N/A
11/32"	0.313–0.375	44106	44155
3/8"	0.344–0.406	44107	44156
13/32"	0.375–0.437	44108	44157
7/16"	0.407–0.469	44109	44158
15/32"	0.438–0.500	44110	44159
1/2"	0.469–0.531	44111	44160
17/32"	0.500–0.562	44112	44161
9/16"	0.532–0.594	44113	44162
19/32"	0.563–0.625	44114	44163
5/8"	0.594–0.656	44115	44164
21/32"	0.625–0.687	44116	44165

NOMINAL SIZE	RANGE (INCHES)	SMOOTH PART NUMBER	SERRATED PART NUMBER
11/16"	0.657–0.719	44117	44166
23/32"	0.688–0.750	44118	44167
3/4"	0.719–0.781	44119	44168
29/32"	0.750–0.812	44120	44169
13/16"	0.782–0.844	44121	44170
27/32"	0.813–0.875	44122	44171
7/8"	0.844–0.906	44123	44172
29/32"	0.875–0.937	44124	44173
15/16"	0.907–0.969	44125	44174
31/32"	0.938–1.000	44126	44175
1"	0.969–1.031	44127	44176
11/32"	1.000–1.062	44128	Call
11/16"	1.032–1.094	44129	44177
13/32"	1.063–1.125	44130	Call
13/8"	1.094–1.156	44131	44178
15/32"	1.125–1.187	44132	Call

NOMINAL SIZE	RANGE (INCHES)	SMOOTH PART NUMBER	SERRATED PART NUMBER
13/16"	1.157–1.219	44133	44179
17/32"	1.188–1.250	44134	Call
11/4"	1.219–1.281	44135	44180
19/32"	1.250–1.312	44136	Call
15/16"	1.282–1.344	44137	44181
111/32"	1.313–1.375	44138	Call
13/8"	1.344–1.406	44139	44182
113/32"	1.375–1.437	44140	Call
17/16"	1.407–1.469	44141	44183
115/32"	1.438–1.500	44142	Call
11/2"	1.469–1.531	44143	44184
117/32"	1.500–1.562	44144	Call
19/16"	1.532–1.594	44145	44185
119/32"	1.563–1.625	44146	Call
13/8"	1.594–1.656	44147	44186

ROYAL ULTRA-PRECISION QUICK-GRIP™ COLLETS

QG-42



Royal QG-42 Round Collets (Metric) – \$297 Each

NOMINAL SIZE	RANGE (mm)	SMOOTH PART NUMBER	SERRATED PART NUMBER
4mm	3.25-4.75	62100	N/A
5mm	4.25-5.75	62102	N/A
6mm	5.25-6.75	62104	N/A
7mm	6.25-7.75	62106	N/A
8mm	7.25-8.75	62108	N/A
9mm	8.25-9.75	62110	62200
10mm	9.25-10.75	62112	62201
11mm	10.25-11.75	62114	62202
12mm	11.25-12.75	62116	62203
13mm	12.25-13.75	62118	62204
14mm	13.25-14.75	62120	62205
15mm	14.25-15.75	62122	62206
16mm	15.25-16.75	62124	62207

NOMINAL SIZE	RANGE (mm)	SMOOTH PART NUMBER	SERRATED PART NUMBER
17mm	16.25-17.75	62126	62208
18mm	17.25-18.75	62128	62209
19mm	18.25-19.75	62130	62210
20mm	19.25-20.75	62132	62211
21mm	20.25-21.75	62134	62212
22mm	21.25-22.75	62136	62213
23mm	22.25-23.75	62138	62214
24mm	23.25-24.75	62140	62215
25mm	24.25-25.75	62142	62216
26mm	25.25-26.75	62144	62217
27mm	26.25-27.75	62146	62218
28mm	27.25-28.75	62148	62219
29mm	28.25-29.75	62150	62220

NOMINAL SIZE	RANGE (mm)	SMOOTH PART NUMBER	SERRATED PART NUMBER
30mm	29.25-30.75	62152	62221
31mm	30.25-31.75	62154	62222
32mm	31.25-32.75	62156	62223
33mm	32.25-33.75	62158	62224
34mm	33.25-34.75	62160	62225
35mm	34.25-35.75	62162	62226
36mm	35.25-36.75	62164	62227
37mm	36.25-37.75	62166	62228
38mm	37.25-38.75	62168	62229
39mm	38.25-39.75	62170	62230
40mm	39.25-40.75	62172	62231
41mm	40.25-41.75	62174	62232
42mm	41.25-42.75	62176	62233

Royal QG-42 Hex Collets – \$443 Each

NOMINAL SIZE	RANGE (INCHES)	PART NUMBER
¼"	0.219-0.281	44375
⅜"	0.344-0.406	44377
½"	0.469-0.531	44379
⅝"	0.594-0.656	44381

NOMINAL SIZE	RANGE (INCHES)	PART NUMBER
¾"	0.719-0.781	44383
⅞"	0.844-0.906	44385
1"	0.969-1.031	44387
1 ⅛"	1.094-1.156	44389

NOMINAL SIZE	RANGE (INCHES)	PART NUMBER
1 ¼"	1.219-1.281	44391
1 ⅜"	1.344-1.406	44393

Royal QG-42 Square Collets – \$443 Each

NOMINAL SIZE	RANGE (INCHES)	PART NUMBER
¼"	0.219-0.281	44670
⅜"	0.344-0.406	44672
½"	0.469-0.531	44674

NOMINAL SIZE	RANGE (INCHES)	PART NUMBER
⅝"	0.594-0.656	44676
¾"	0.719-0.781	44678
⅞"	0.844-0.906	44680

NOMINAL SIZE	RANGE (INCHES)	PART NUMBER
1"	0.969-1.031	44682
1 ⅛"	1.094-1.156	44684

Royal QG-42 Emergency Collets – \$348 Each – See Page 38



Check out the Royal Quick-Grip™ CNC Collet Chuck Video at www.colletchucks.com



ROYAL ULTRA-PRECISION QUICK-GRIP™ COLLETS

QG-52

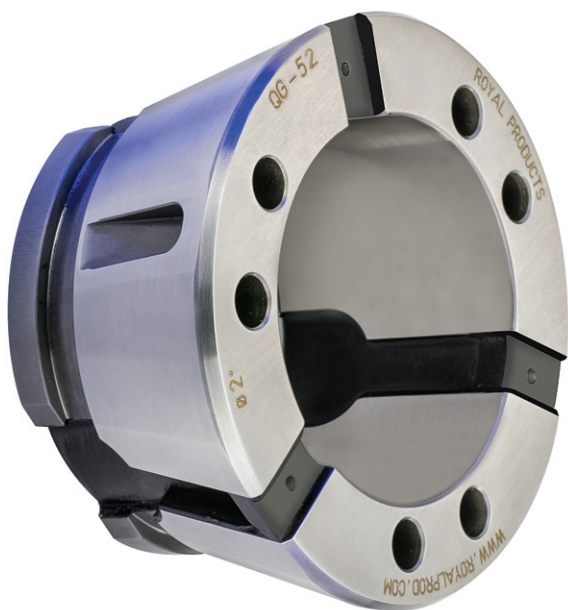

QG-52 CAPACITY

Bar Diameter	2.03" (51.6mm)
Slug Diameter*	2.57" (64.3mm)

* See page 38 for details.

- ❑ Huge inventory of Round, Hex, Square, and Emergency styles always in stock, ready for same-day shipping.
- ❑ Smooth and serrated versions for round-bore models (all others smooth only).
- ❑ **Industry-leading 0.062" gripping range** covers a wide range of part diameters. Collets are ground to nominal size and have a range of +/- 0.031".
- ❑ Parallel-grip ensures full-length part contact for maximum grip force, rigidity, and accuracy.
- ❑ Can be counter-bored for increased part capacity up to 2.57" – see page 38 for details.
- ❑ Quick-ship specials available for custom shapes.
- ❑ Can utilize manual and pneumatic changing tools.

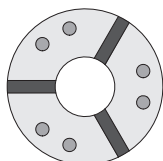

Round Inch

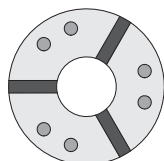

Round Metric

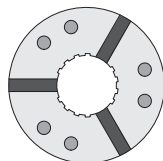

Serrated

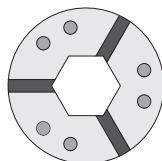

Hex

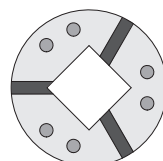

Square

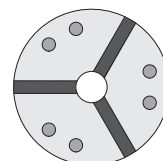

Emergency

Royal QG-52 Round Collets (Inch) – \$297 Each

NOMINAL SIZE	RANGE (INCHES)	SMOOTH PART NUMBER	SERRATED PART NUMBER
3/16"	0.157–0.219	45600	N/A
7/32"	0.188–0.250	45601	N/A
1/4"	0.219–0.281	45602	N/A
9/32"	0.250–0.312	45603	N/A
5/16"	0.282–0.344	45604	N/A
11/32"	0.313–0.375	45605	45665
3/8"	0.344–0.406	45606	45666
13/32"	0.375–0.437	45607	45667
7/16"	0.407–0.469	45608	45668
15/32"	0.438–0.500	45609	45669
1/2"	0.469–0.531	45610	45670
17/32"	0.500–0.562	45611	45671
9/16"	0.532–0.594	45612	45672
19/32"	0.563–0.625	45613	45673
5/8"	0.594–0.656	45614	45674
21/32"	0.625–0.687	45615	45675
11/16"	0.657–0.719	45616	45676
23/32"	0.688–0.750	45617	45677
3/4"	0.719–0.781	45618	45678
25/32"	0.750–0.812	45619	45679

NOMINAL SIZE	RANGE (INCHES)	SMOOTH PART NUMBER	SERRATED PART NUMBER
13/16"	0.782–0.844	45620	45680
27/32"	0.813–0.875	45621	45681
7/8"	0.844–0.906	45622	45682
29/32"	0.875–0.937	45623	45683
15/16"	0.907–0.969	45624	45684
31/32"	0.938–1.000	45625	45685
1"	0.969–1.031	45626	45686
1 1/32"	1.000–1.062	45627	N/A
1 1/16"	1.032–1.094	45628	45687
1 1/8"	1.063–1.125	45629	N/A
1 1/4"	1.094–1.156	45630	45688
1 3/8"	1.125–1.187	45631	N/A
1 1/2"	1.157–1.219	45632	45689
1 5/8"	1.188–1.250	45633	N/A
1 3/4"	1.219–1.281	45634	45690
1 7/8"	1.250–1.312	45635	N/A
1 15/16"	1.282–1.344	45636	45691
1 1/2"	1.313–1.375	45637	N/A
1 5/8"	1.344–1.406	45638	45692
1 13/16"	1.375–1.437	45639	N/A

NOMINAL SIZE	RANGE (INCHES)	SMOOTH PART NUMBER	SERRATED PART NUMBER
1 7/16"	1.407–1.469	45640	45693
1 15/32"	1.438–1.500	45641	N/A
1 1/2"	1.469–1.531	45642	45694
1 17/32"	1.500–1.562	45643	N/A
1 9/16"	1.532–1.594	45644	45695
1 19/32"	1.563–1.625	45645	N/A
1 5/8"	1.594–1.656	45646	45696
1 21/32"	1.625–1.687	45647	N/A
1 11/16"	1.657–1.719	45648	45697
1 23/32"	1.688–1.750	45649	N/A
1 3/4"	1.719–1.781	45650	45698
1 25/32"	1.750–1.812	45651	N/A
1 13/16"	1.782–1.844	45652	45699
1 27/32"	1.813–1.875	45653	N/A
1 5/8"	1.844–1.906	45654	45700
1 29/32"	1.875–1.937	45655	N/A
1 15/16"	1.907–1.969	45656	45701
1 31/32"	1.938–2.000	45657	N/A
2"	1.969–2.031	45658	45702

ROYAL ULTRA-PRECISION QUICK-GRIP™ COLLETS

QG-52



Royal QG-52 Round Collets (Metric) – \$297 Each

NOMINAL SIZE	RANGE (mm)	SMOOTH PART NUMBER	SERRATED PART NUMBER
4mm	3.25–4.75	63200	N/A
5mm	4.25–5.75	63201	N/A
6mm	5.25–6.75	63202	N/A
7mm	6.25–7.75	63203	N/A
8mm	7.25–8.75	63204	N/A
9mm	8.25–9.75	63205	63250
10mm	9.25–10.75	63206	63251
11mm	10.25–11.75	63207	63252
12mm	11.25–12.75	63208	63253
13mm	12.25–13.75	63209	63254
14mm	13.25–14.75	63210	63255
15mm	14.25–15.75	63211	63256
16mm	15.25–16.75	63212	63257
17mm	16.25–17.75	63213	63258
18mm	17.25–18.75	63214	63259
19mm	18.25–19.75	63215	63260
20mm	19.25–20.75	63216	63261

NOMINAL SIZE	RANGE (mm)	SMOOTH PART NUMBER	SERRATED PART NUMBER
21mm	20.25–21.75	63217	63262
22mm	21.25–22.75	63218	63263
23mm	22.25–23.75	63219	63264
24mm	23.25–24.75	63220	63265
25mm	24.25–25.75	63221	63266
26mm	25.25–26.75	63222	63267
27mm	26.25–27.75	63223	63268
28mm	27.25–28.75	63224	63269
29mm	28.25–29.75	63225	63270
30mm	29.25–30.75	63226	63271
31mm	30.25–31.75	63227	63272
32mm	31.25–32.75	63228	63273
33mm	32.25–33.75	63229	63274
34mm	33.25–34.75	63230	63275
35mm	34.25–35.75	63231	63276
36mm	35.25–36.75	63232	63277
37mm	36.25–37.75	63233	63278

NOMINAL SIZE	RANGE (mm)	SMOOTH PART NUMBER	SERRATED PART NUMBER
38mm	37.25–38.75	63234	63279
39mm	38.25–39.75	63235	63280
40mm	39.25–40.75	63236	63281
41mm	40.25–41.75	63237	63282
42mm	41.25–42.75	63238	63283
43mm	42.25–43.75	63239	63284
44mm	43.25–44.75	63240	63285
45mm	44.25–45.75	63241	63286
46mm	45.25–46.75	63242	63287
47mm	46.25–47.75	63243	63288
48mm	47.25–48.75	63244	63289
49mm	48.25–49.75	63245	63290
50mm	49.25–50.75	63246	63291
51mm	50.25–51.75	63247	63292
52mm	51.25–52.75	63248	63293

Royal QG-52 Hex Collets – \$443 Each

NOMINAL SIZE	RANGE (INCHES)	PART NUMBER
1/4"	0.219–0.281	45710
5/16"	0.282–0.344	45711
3/8"	0.344–0.406	45712
7/16"	0.407–0.469	45713
1/2"	0.469–0.531	45714
9/16"	0.532–0.594	45715
5/8"	0.594–0.656	45716
11/16"	0.657–0.719	45717
3/4"	0.719–0.781	45718

NOMINAL SIZE	RANGE (INCHES)	PART NUMBER
13/16"	0.782–0.844	45719
7/8"	0.844–0.906	45720
15/16"	0.907–0.969	45721
1"	0.969–1.031	45722
1 1/16"	1.032–1.094	45723
1 1/8"	1.094–1.156	45724
1 1/4"	1.156–1.219	45725
1 1/2"	1.219–1.281	45726
1 5/8"	1.281–1.344	45727

NOMINAL SIZE	RANGE (INCHES)	PART NUMBER
1 3/8"	1.344–1.406	45728
1 1/2"	1.406–1.469	45729
1 5/8"	1.469–1.531	45730
1 3/4"	1.531–1.594	45731
1 7/8"	1.594–1.656	45732
1 15/16"	1.656–1.719	45733
1 3/4"	1.719–1.781	45734

Royal QG-52 Square Collets – \$443 Each

NOMINAL SIZE	RANGE (INCHES)	PART NUMBER
1/4"	0.219–0.281	45740
3/8"	0.344–0.406	45742
1/2"	0.469–0.531	45744
5/8"	0.594–0.656	45746

NOMINAL SIZE	RANGE (INCHES)	PART NUMBER
3/4"	0.719–0.781	45748
7/8"	0.844–0.906	45750
1"	0.969–1.031	45752
1 1/8"	1.094–1.156	45754

NOMINAL SIZE	RANGE (INCHES)	PART NUMBER
1 1/4"	1.219–1.281	45756
1 3/8"	1.344–1.406	45758

Royal QG-52 Emergency Collets – \$348 Each – See Page 38



Check out the Royal Quick-Grip™ CNC Collet Chuck Video at www.colletchucks.com



ROYAL ULTRA-PRECISION QUICK-GRIP™ COLLETS

QG-65

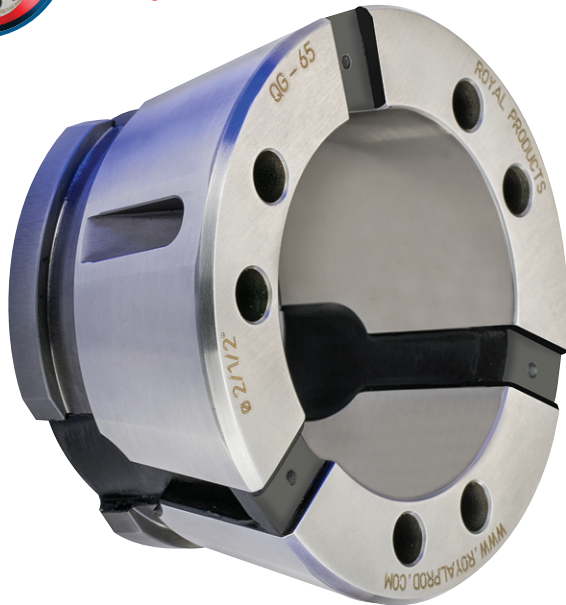

QG-65 CAPACITY	
Bar Diameter	2.66" (65.8mm)
Slug Diameter*	3.40" (86.4mm)

* See page 38 for details.

- Huge inventory of Round, Hex, Square, and Emergency styles always in stock, ready for same-day shipping.
- Industry-leading 0.062" gripping range covers a wide range of part diameters. Collets are ground to nominal size and have a range of +/- 0.031".
- Parallel-grip ensures **full-length part contact for maximum grip force, rigidity, and accuracy.**
- Can be counter-bored for increased part capacity up to 3.40" – see page 38 for details.
- Quick-ship specials available for custom shapes.
- Can utilize manual and pneumatic changing tools.

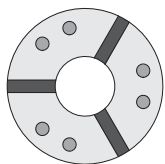

Round Inch

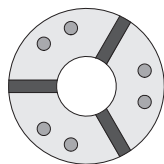

Round Metric

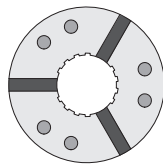

Serrated

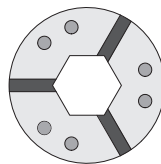

Hex

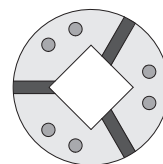

Square

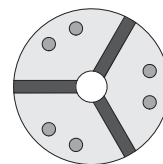

Emergency

Royal QG-65 Round Collets (Inch) – \$348 Each

NOMINAL SIZE	RANGE (INCHES)	SMOOTH PART NUMBER	SERRATED PART NUMBER
3/16"	0.157–0.219	44201	N/A
7/32"	0.188–0.250	44202	N/A
1/4"	0.219–0.281	44203	N/A
9/32"	0.250–0.312	44204	N/A
5/16"	0.282–0.344	44205	N/A
11/32"	0.313–0.375	44206	44306
3/8"	0.344–0.406	44207	44307
13/32"	0.375–0.437	44208	44308
7/16"	0.407–0.469	44209	44309
15/32"	0.438–0.500	44210	44310
1/2"	0.469–0.531	44211	44311
17/32"	0.500–0.562	44212	44312
9/16"	0.532–0.594	44213	44313
19/32"	0.563–0.625	44214	44314
5/8"	0.594–0.656	44215	44315
21/32"	0.625–0.687	44216	44316
11/16"	0.657–0.719	44217	44317
23/32"	0.688–0.750	44218	44318
3/4"	0.719–0.781	44219	44319
25/32"	0.750–0.812	44220	44320
13/16"	0.782–0.844	44221	44321
27/32"	0.813–0.875	44222	44322
7/8"	0.844–0.906	44223	44323
29/32"	0.875–0.937	44224	44324
15/16"	0.907–0.969	44225	44325
31/32"	0.938–1.000	44226	44326
1"	0.969–1.031	44227	44327

NOMINAL SIZE	RANGE (INCHES)	SMOOTH PART NUMBER	SERRATED PART NUMBER
1 1/32"	1.000–1.062	44228	Call
1 1/16"	1.032–1.094	44229	44328
1 1/32"	1.063–1.125	44230	Call
1 1/8"	1.094–1.156	44231	44329
1 1/32"	1.125–1.187	44232	Call
1 1/16"	1.157–1.219	44233	44330
1 1/32"	1.188–1.250	44234	Call
1 1/4"	1.219–1.281	44235	44331
1 1/32"	1.250–1.312	44236	Call
1 1/16"	1.282–1.344	44237	44332
1 11/32"	1.313–1.375	44238	Call
1 3/8"	1.344–1.406	44239	44333
1 13/32"	1.375–1.437	44240	Call
1 1/2"	1.407–1.469	44241	44334
1 15/32"	1.438–1.500	44242	Call
1 1/2"	1.469–1.531	44243	44335
1 17/32"	1.500–1.562	44244	Call
1 9/16"	1.532–1.594	44245	44336
1 19/32"	1.563–1.625	44246	Call
1 5/8"	1.594–1.656	44247	44337
1 21/32"	1.625–1.687	44248	Call
1 11/16"	1.657–1.719	44249	44338
1 23/32"	1.688–1.750	44250	Call
1 3/4"	1.719–1.781	44251	44339
1 25/32"	1.750–1.812	44252	Call
1 13/16"	1.782–1.844	44253	44340
1 27/32"	1.813–1.875	44254	Call

NOMINAL SIZE	RANGE (INCHES)	SMOOTH PART NUMBER	SERRATED PART NUMBER
1 7/8"	1.844–1.906	44255	44341
1 29/32"	1.875–1.937	44256	Call
1 15/16"	1.907–1.969	44257	44342
1 31/32"	1.938–2.000	44279	Call
2"	1.969–2.031	44258	44343
2 1/32"	2.000–2.062	44259	Call
2 1/16"	2.032–2.094	44260	44344
2 3/32"	2.063–2.125	44261	Call
2 1/8"	2.094–2.156	44262	44345
2 5/32"	2.125–2.187	44263	Call
2 3/16"	2.157–2.219	44264	44346
2 1/2"	2.188–2.250	44265	Call
2 7/16"	2.219–2.281	44266	44347
2 9/32"	2.250–2.312	44267	Call
2 5/16"	2.282–2.344	44268	44348
2 11/32"	2.313–2.375	44269	Call
2 3/8"	2.344–2.406	44270	44349
2 13/32"	2.375–2.437	44271	Call
2 7/16"	2.407–2.469	44272	44350
2 15/32"	2.438–2.500	44273	Call
2 1/2"	2.469–2.531	44274	44351
2 17/32"	2.500–2.562	44275	Call
2 9/16"	2.532–2.594	44276	44352
2 19/32"	2.563–2.625	44277	N/A
2 5/8"	2.594–2.656	44278	N/A



ROYAL ULTRA-PRECISION QUICK-GRIP™ COLLETS

QG-65

Royal QG-65 Round Collets (Metric) – \$348 Each

NOMINAL SIZE	RANGE (mm)	SMOOTH PART NUMBER	SERRATED PART NUMBER
4mm	3.25–4.75	62300	N/A
5mm	4.25–5.75	62302	N/A
6mm	5.25–6.75	62304	N/A
7mm	6.25–7.75	62306	N/A
8mm	7.25–8.75	62308	N/A
9mm	8.25–9.75	62310	62500
10mm	9.25–10.75	62312	62501
11mm	10.25–11.75	62314	62502
12mm	11.25–12.75	62316	62503
13mm	12.25–13.75	62318	62504
14mm	13.25–14.75	62320	62505
15mm	14.25–15.75	62322	62506
16mm	15.25–16.75	62324	62507
17mm	16.25–17.75	62326	62508
18mm	17.25–18.75	62328	62509
19mm	18.25–19.75	62330	62510
20mm	19.25–20.75	62332	62511
21mm	20.25–21.75	62334	62512
22mm	21.25–22.75	62336	62513
23mm	22.25–23.75	62338	62514
24mm	23.25–24.75	62340	62515

NOMINAL SIZE	RANGE (mm)	SMOOTH PART NUMBER	SERRATED PART NUMBER
25mm	24.25–25.75	62342	62516
26mm	25.25–26.75	62344	62517
27mm	26.25–27.75	62346	62518
28mm	27.25–28.75	62348	62519
29mm	28.25–29.75	62350	62520
30mm	29.25–30.75	62352	62521
31mm	30.25–31.75	62354	62522
32mm	31.25–32.75	62356	62523
33mm	32.25–33.75	62358	62524
34mm	33.25–34.75	62360	62525
35mm	34.25–35.75	62362	62526
36mm	35.25–36.75	62364	62527
37mm	36.25–37.75	62366	62528
38mm	37.25–38.75	62368	62529
39mm	38.25–39.75	62370	62530
40mm	39.25–40.75	62372	62531
41mm	40.25–41.75	62374	62532
42mm	41.25–42.75	62376	62533
43mm	42.25–43.75	62378	62534
44mm	43.25–44.75	62380	62535
45mm	44.25–45.75	62382	62536

NOMINAL SIZE	RANGE (mm)	SMOOTH PART NUMBER	SERRATED PART NUMBER
46mm	45.25–46.75	62384	62537
47mm	46.25–47.75	62386	62538
48mm	47.25–48.75	62388	62539
49mm	48.25–49.75	62390	62540
50mm	49.25–50.75	62392	62541
51mm	50.25–51.75	62394	62542
52mm	51.25–52.75	62396	62543
53mm	52.25–53.75	62398	62544
54mm	53.25–54.75	62400	62545
55mm	54.25–55.75	62402	62546
56mm	55.25–56.75	62404	62547
57mm	56.25–57.75	62406	62548
58mm	57.25–58.75	62408	62549
59mm	58.25–59.75	62410	62550
60mm	59.25–60.75	62412	N/A
61mm	60.25–61.75	62414	N/A
62mm	61.25–62.75	62416	N/A
63mm	62.25–63.75	62418	N/A
64mm	63.25–64.75	62420	N/A
65mm	64.25–65.75	62422	N/A

Royal QG-65 Hex Collets – \$558 Each

NOMINAL SIZE	RANGE (INCHES)	PART NUMBER
5/16"	0.282–0.344	44700
3/8"	0.344–0.406	44701
7/16"	0.407–0.469	44702
1/2"	0.469–0.531	44703
9/16"	0.532–0.594	44704
5/8"	0.594–0.656	44705
11/16"	0.657–0.719	44706
3/4"	0.719–0.781	44707
13/16"	0.782–0.844	44708
7/8"	0.844–0.906	44709
15/16"	0.907–0.969	44710

NOMINAL SIZE	RANGE (INCHES)	PART NUMBER
1"	0.969–1.031	44711
1 1/16"	1.032–1.094	44712
1 1/8"	1.094–1.156	44713
1 3/16"	1.156–1.219	44714
1 1/4"	1.219–1.281	44715
1 5/16"	1.281–1.344	44716
1 3/8"	1.344–1.406	44717
1 7/16"	1.406–1.469	44718
1 1/2"	1.469–1.531	44719
1 5/8"	1.531–1.594	44720
1 5/8"	1.594–1.656	44721

NOMINAL SIZE	RANGE (INCHES)	PART NUMBER
1 11/16"	1.656–1.719	44722
1 3/4"	1.719–1.781	44723
1 13/16"	1.781–1.844	44724
1 7/8"	1.844–1.906	44725
1 15/16"	1.906–1.969	44726
2"	1.969–2.031	44727
2 1/16"	2.031–2.094	44728
2 1/8"	2.094–2.156	44729
2 3/16"	2.156–2.219	44730
2 1/4"	2.219–2.281	44731

Royal QG-65 Square Collets – \$558 Each

NOMINAL SIZE	RANGE (INCHES)	PART NUMBER
3/8"	0.344–0.406	44787
1/2"	0.469–0.531	44734
5/8"	0.594–0.656	44788
3/4"	0.719–0.781	44735

NOMINAL SIZE	RANGE (INCHES)	PART NUMBER
7/8"	0.844–0.906	44789
1"	0.969–1.031	44736
1 1/8"	1.094–1.156	44790
1 1/4"	1.219–1.281	44737

NOMINAL SIZE	RANGE (INCHES)	PART NUMBER
1 3/8"	1.344–1.406	44791
1 1/2"	1.469–1.531	44738
1 5/8"	1.594–1.656	44792
1 3/4"	1.719–1.781	44739

Royal QG-65 Emergency Collets – \$391 Each – See Page 38



ROYAL ULTRA-PRECISION QUICK-GRIP™ COLLETS

QG-80

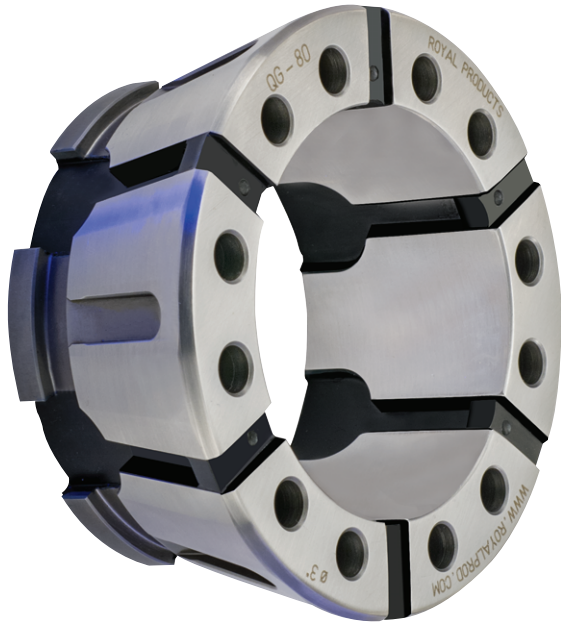

QG-80 CAPACITY	
Bar Diameter	3.28" (80.8mm)
Slug Diameter*	4.00" (101.6mm)

* See page 38 for details.

- ❑ Huge inventory of Round, Hex, Square, and Emergency styles **always in stock, ready for same-day shipping.**
- ❑ **Industry-leading 0.062" gripping range** covers a wide range of part diameters. Collets are ground to nominal size and have a range of +/- 0.031".
- ❑ Parallel-grip ensures full-length part contact for maximum grip force, rigidity, and accuracy.
- ❑ Six-segment design further increases gripping torque.
- ❑ Can be counter-bored for increased part capacity up to 4.00" – see page 38 for details.
- ❑ Can utilize manual and pneumatic changing tools.

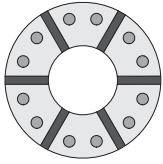

Round Inch

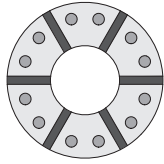

Round Metric

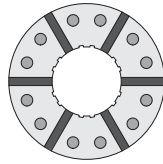

Serrated

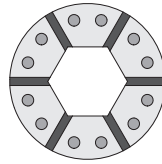

Hex

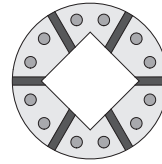

Square

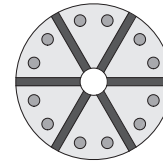

Emergency

Royal QG-80 Round Collets* (Inch) – \$538 Each

NOMINAL SIZE	RANGE (INCHES)	SMOOTH PART NUMBER	SERRATED PART NUMBER
1/4"	0.219–0.281	44403	N/A
5/16"	0.282–0.344	44405	N/A
3/8"	0.344–0.406	44407	N/A
7/16"	0.407–0.469	44409	44509
1/2"	0.469–0.531	44411	44511
9/16"	0.532–0.594	44413	44513
5/8"	0.594–0.656	44415	44515
11/16"	0.657–0.719	44417	44517
3/4"	0.719–0.781	44419	44519
13/16"	0.782–0.844	44421	44521
7/8"	0.844–0.906	44423	44523
15/16"	0.907–0.969	44425	44525
1"	0.969–1.031	44427	44527
1 1/16"	1.032–1.094	44429	44529
1 1/8"	1.094–1.156	44431	44531
1 3/16"	1.157–1.219	44433	44533
1 1/4"	1.219–1.281	44435	44535

NOMINAL SIZE	RANGE (INCHES)	SMOOTH PART NUMBER	SERRATED PART NUMBER
1 5/16"	1.282–1.344	44437	44537
1 3/8"	1.344–1.406	44439	44539
1 7/16"	1.407–1.469	44441	44541
1 1/2"	1.469–1.531	44443	44543
1 5/8"	1.532–1.594	44445	44545
1 5/8"	1.594–1.656	44447	44547
1 11/16"	1.657–1.719	44449	44549
1 3/4"	1.719–1.781	44451	44551
1 13/16"	1.782–1.844	44453	44553
1 7/8"	1.844–1.906	44455	44555
1 15/16"	1.907–1.969	44457	44557
2"	1.969–2.031	44459	44559
2 1/16"	2.032–2.094	44461	44561
2 1/8"	2.094–2.156	44463	44563
2 3/16"	2.157–2.219	44465	44565
2 1/4"	2.219–2.281	44467	44567
2 5/16"	2.282–2.344	44469	44569

NOMINAL SIZE	RANGE (INCHES)	SMOOTH PART NUMBER	SERRATED PART NUMBER
2 5/8"	2.344–2.406	44471	44571
2 7/16"	2.407–2.469	44473	44573
2 1/2"	2.469–2.531	44475	44575
2 9/16"	2.532–2.594	44477	44577
2 5/8"	2.594–2.656	44479	44579
2 11/16"	2.657–2.719	44481	44581
2 3/4"	2.719–2.781	44483	44583
2 13/16"	2.782–2.844	44485	44585
2 7/8"	2.844–2.906	44487	44587
2 15/16"	2.907–2.969	44489	44589
3"	2.969–3.031	44491	44591
3 1/16"	3.032–3.094	44493	N/A
3 3/8"	3.094–3.156	44495	N/A
3 5/16"	3.157–3.219	44497	N/A
3 1/4"	3.219–3.281	44499	N/A

*Royal QG-80 collets have six segments instead of three for increased gripping torque.



ROYAL ULTRA-PRECISION QUICK-GRIP™ COLLETS

QG-80

Royal QG-80 Round Collets* (Metric) – \$538 Each

NOMINAL SIZE	RANGE (mm)	SMOOTH PART NUMBER	SERRATED PART NUMBER	NOMINAL SIZE	RANGE (mm)	SMOOTH PART NUMBER	SERRATED PART NUMBER	NOMINAL SIZE	RANGE (mm)	SMOOTH PART NUMBER	SERRATED PART NUMBER
7mm	6.25-7.75	62600	N/A	32mm	31.25-32.75	62650	62821	57mm	56.25-57.75	62700	62846
8mm	7.25-8.75	62602	N/A	33mm	32.25-33.75	62652	62822	58mm	57.25-58.75	62702	62847
9mm	8.25-9.75	62604	N/A	34mm	33.25-34.75	62654	62823	59mm	58.25-59.75	62704	62848
10mm	9.25-10.75	62606	N/A	35mm	34.25-35.75	62656	62824	60mm	59.25-60.75	62706	62849
11mm	10.25-11.75	62608	62800	36mm	35.25-36.75	62658	62825	61mm	60.25-61.75	62708	62850
12mm	11.25-12.75	62610	62801	37mm	36.25-37.75	62660	62826	62mm	61.25-62.75	62710	62851
13mm	12.25-13.75	62612	62802	38mm	37.25-38.75	62662	62827	63mm	62.25-63.75	62712	62852
14mm	13.25-14.75	62614	62803	39mm	38.25-39.75	62664	62828	64mm	63.25-64.75	62714	62853
15mm	14.25-15.75	62616	62804	40mm	39.25-40.75	62666	62829	65mm	64.25-65.75	62716	62854
16mm	15.25-16.75	62618	62805	41mm	40.25-41.75	62668	62830	66mm	65.25-66.75	62718	62855
17mm	16.25-17.75	62620	62806	42mm	41.25-42.75	62670	62831	67mm	66.25-67.75	62720	62856
18mm	17.25-18.75	62622	62807	43mm	42.25-43.75	62672	62832	68mm	67.25-68.75	62722	62857
19mm	18.25-19.75	62624	62808	44mm	43.25-44.75	62674	62833	69mm	68.25-69.75	62724	62858
20mm	19.25-20.75	62626	62809	45mm	44.25-45.75	62676	62834	70mm	69.25-70.75	62726	62859
21mm	20.25-21.75	62628	62810	46mm	45.25-46.75	62678	62835	71mm	70.25-71.75	62728	62860
22mm	21.25-22.75	62630	62811	47mm	46.25-47.75	62680	62836	72mm	71.25-72.75	62730	62861
23mm	22.25-23.75	62632	62812	48mm	47.25-48.75	62682	62837	73mm	72.25-73.75	62732	62862
24mm	23.25-24.75	62634	62813	49mm	48.25-49.75	62684	62838	74mm	73.25-74.75	62734	62863
25mm	24.25-25.75	62636	62814	50mm	49.25-50.75	62686	62839	75mm	74.25-75.75	62736	62864
26mm	25.25-26.75	62638	62815	51mm	50.25-51.75	62688	62840	76mm	75.25-76.75	62738	62865
27mm	26.25-27.75	62640	62816	52mm	51.25-52.75	62690	62841	77mm	76.25-77.75	62740	62866
28mm	27.25-28.75	62642	62817	53mm	52.25-53.75	62692	62842	78mm	77.25-78.75	62742	N/A
29mm	28.25-29.75	62644	62818	54mm	53.25-54.75	62694	62843	79mm	78.25-79.75	62744	N/A
30mm	29.25-30.75	62646	62819	55mm	54.25-55.75	62696	62844	80mm	79.25-80.75	62746	N/A
31mm	30.25-31.75	62648	62820	56mm	55.25-56.75	62698	62845				

*Royal QG-80 collets have six segments instead of three for increased gripping torque.

Royal QG-80 Hex Collets* – \$830 Each

NOMINAL SIZE	RANGE (INCHES)	PART NUMBER	NOMINAL SIZE	RANGE (INCHES)	PART NUMBER	NOMINAL SIZE	RANGE (INCHES)	PART NUMBER
3/8"	0.344-0.406	44778	1 3/16"	1.156-1.219	44752	2"	1.969-2.031	44765
7/16"	0.407-0.469	44740	1 1/4"	1.219-1.281	44753	2 1/16"	2.031-2.094	44766
1/2"	0.469-0.531	44741	1 5/16"	1.281-1.344	44754	2 1/8"	2.094-2.156	44767
9/16"	0.532-0.594	44742	1 3/8"	1.344-1.406	44755	2 3/16"	2.156-2.219	44768
5/8"	0.594-0.656	44743	1 7/16"	1.406-1.469	44756	2 1/4"	2.219-2.281	44769
1 1/16"	0.657-0.719	44744	1 1/2"	1.469-1.531	44757	2 5/16"	2.281-2.344	44770
3/4"	0.719-0.781	44745	1 9/16"	1.531-1.594	44758	2 3/8"	2.344-2.406	44771
13/16"	0.782-0.844	44746	1 5/8"	1.594-1.656	44759	2 7/16"	2.406-2.469	44772
7/8"	0.844-0.906	44747	1 11/16"	1.656-1.719	44760	2 1/2"	2.469-2.531	44773
15/16"	0.907-0.969	44748	1 3/4"	1.719-1.781	44761	2 9/16"	2.531-2.594	44774
1"	0.969-1.031	44749	1 13/16"	1.781-1.844	44762	2 5/8"	2.594-2.656	44775
1 1/16"	1.032-1.094	44750	1 7/8"	1.844-1.906	44763	2 11/16"	2.656-2.719	44776
1 1/8"	1.094-1.156	44751	1 15/16"	1.906-1.969	44764	2 3/4"	2.719-2.781	44777

*Royal QG-80 collets have six segments instead of three for increased gripping torque.

Royal QG-80 Square Collets* – \$830 Each

NOMINAL SIZE	RANGE (INCHES)	PART NUMBER	NOMINAL SIZE	RANGE (INCHES)	PART NUMBER	NOMINAL SIZE	RANGE (INCHES)	PART NUMBER
3/8"	0.344-0.406	44793	1"	0.969-1.031	44782	1 5/8"	1.594-1.656	44798
1/2"	0.469-0.531	44780	1 1/8"	1.094-1.156	44796	1 3/4"	1.719-1.781	44785
5/8"	0.594-0.656	44794	1 1/4"	1.219-1.281	44783	1 7/8"	1.844-1.906	44799
3/4"	0.719-0.781	44781	1 3/8"	1.344-1.406	44797	2"	1.969-2.031	44786
7/8"	0.844-0.906	44795	1 1/2"	1.469-1.531	44784			

*Royal QG-80 collets have six segments instead of three for increased gripping torque.

Royal QG-80 Emergency Collets – \$590 Each – See Page 38



ROYAL ULTRA-PRECISION QUICK-GRIP™ COLLETS

QG-100



QG-100 CAPACITY	
Bar Diameter	4.03" (100.8mm)
Slug Diameter*	5.15" (130.8mm)

* See page 38 for details.

- Huge inventory of Round, Hex, Square, and Emergency styles always in stock, ready for same-day shipping.
- Smooth and serrated versions for round-bore models (all others smooth only).
- **Industry-leading 0.080" gripping range** covers a wide range of part diameters. Collets are ground to nominal size and have a range of +/- 0.040".
- Parallel-grip ensures full-length part contact for maximum grip force, rigidity, and accuracy.
- Six-segment design further increases gripping torque.
- Can be counter-bored for increased part capacity up to 5.15" – see page 38 for details.
- Quick-ship specials available for custom shapes.
- Utilizes pneumatic changing tool.

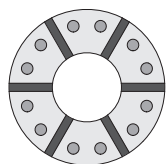

Round Inch

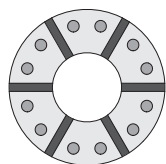

Round Metric

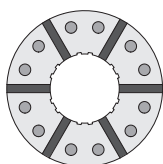

Serrated

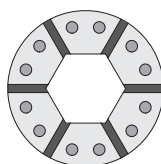

Hex

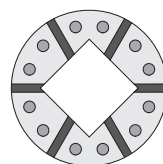

Square

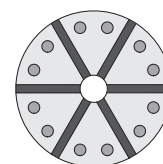

Emergency

Royal QG-100 **Round Collets*** (Inch) – \$803 Each

NOMINAL SIZE	RANGE (INCHES)	SMOOTH PART NUMBER	SERRATED PART NUMBER
5/8"	0.585–0.665	45012	N/A
11/16"	0.648–0.728	45013	N/A
3/4"	0.710–0.790	45014	N/A
13/16"	0.773–0.853	45015	N/A
7/8"	0.835–0.915	45016	N/A
15/16"	0.898–0.978	45017	N/A
1"	0.960–1.040	45018	N/A
1 1/16"	1.023–1.103	45019	N/A
1 1/8"	1.085–1.165	45020	N/A
1 1/16"	1.148–1.228	45021	N/A
1 1/4"	1.210–1.290	45022	N/A
1 5/16"	1.273–1.353	45023	N/A
1 3/8"	1.335–1.415	45024	N/A
1 7/16"	1.398–1.478	45025	N/A
1 1/2"	1.460–1.540	45026	45201
1 9/16"	1.523–1.603	45027	45202
1 5/8"	1.585–1.665	45028	45203
1 11/16"	1.648–1.728	45029	45204
1 3/4"	1.710–1.790	45030	45205

NOMINAL SIZE	RANGE (INCHES)	SMOOTH PART NUMBER	SERRATED PART NUMBER
1 13/16"	1.773–1.853	45031	45206
1 7/8"	1.835–1.915	45032	45207
1 15/16"	1.898–1.978	45033	45208
2"	1.960–2.040	45034	45209
2 1/16"	2.023–2.103	45035	45210
2 1/8"	2.085–2.165	45036	45211
2 3/16"	2.148–2.228	45037	45212
2 1/4"	2.210–2.290	45038	45213
2 5/16"	2.273–2.353	45039	45214
2 3/8"	2.335–2.415	45040	45215
2 7/16"	2.398–2.478	45041	45216
2 1/2"	2.460–2.540	45042	45217
2 9/16"	2.523–2.603	45043	45218
2 5/8"	2.585–2.665	45044	45219
2 11/16"	2.648–2.728	45045	45220
2 3/4"	2.710–2.790	45046	45221
2 13/16"	2.773–2.853	45047	45222
2 7/8"	2.835–2.915	45048	45223
2 15/16"	2.898–2.978	45049	45224

NOMINAL SIZE	RANGE (INCHES)	SMOOTH PART NUMBER	SERRATED PART NUMBER
3"	2.960–3.040	45050	45225
3 1/16"	3.023–3.103	45051	45226
3 1/8"	3.085–3.165	45052	45227
3 3/16"	3.148–3.228	45053	45228
3 1/4"	3.210–3.290	45054	45229
3 5/16"	3.273–3.353	45055	45230
3 3/8"	3.335–3.415	45056	45231
3 7/16"	3.398–3.478	45057	45232
3 1/2"	3.460–3.540	45058	45233
3 9/16"	3.523–3.603	45059	45234
3 5/8"	3.585–3.665	45060	45235
3 11/16"	3.648–3.728	45061	45236
3 3/4"	3.710–3.790	45062	45237
3 13/16"	3.773–3.853	45063	N/A
3 7/8"	3.835–3.915	45064	N/A
3 15/16"	3.898–3.978	45065	N/A
4"	3.960–4.040	45066	N/A

*Royal QG-100 collets have six segments instead of three for increased gripping torque.

ROYAL ULTRA-PRECISION QUICK-GRIP™ COLLETS

QG-100



Royal QG-100 Round Collets* (Metric) – \$803 Each

NOMINAL SIZE	RANGE (mm)	SMOOTH PART NUMBER	SERRATED PART NUMBER
16mm	15.0–17.0	62900	N/A
17mm	16.0–18.0	62902	N/A
18mm	17.0–19.0	62904	N/A
19mm	18.0–20.0	62906	N/A
20mm	19.0–21.0	62908	N/A
21mm	20.0–22.0	62910	N/A
22mm	21.0–23.0	62912	N/A
23mm	22.0–24.0	62914	N/A
24mm	23.0–25.0	62916	N/A
25mm	24.0–26.0	62918	N/A
26mm	25.0–27.0	62920	N/A
27mm	26.0–28.0	62922	N/A
28mm	27.0–29.0	62924	N/A
29mm	28.0–30.0	62926	N/A
30mm	29.0–31.0	62928	N/A
31mm	30.0–32.0	62930	N/A
32mm	31.0–33.0	62932	N/A
33mm	32.0–34.0	62934	N/A
34mm	33.0–35.0	62936	N/A
35mm	34.0–36.0	62938	N/A
36mm	35.0–37.0	62940	N/A
37mm	36.0–38.0	62942	N/A
38mm	37.0–39.0	62944	63100
39mm	38.0–40.0	62946	63101
40mm	39.0–41.0	62948	63102
41mm	40.0–42.0	62950	63103
42mm	41.0–43.0	62952	63104
43mm	42.0–44.0	62954	63105
44mm	43.0–45.0	62956	63106

NOMINAL SIZE	RANGE (mm)	SMOOTH PART NUMBER	SERRATED PART NUMBER
45mm	44.0–46.0	62958	63107
46mm	45.0–47.0	62960	63108
47mm	46.0–48.0	62962	63109
48mm	47.0–49.0	62964	63110
49mm	48.0–50.0	62966	63111
50mm	49.0–51.0	62968	63112
51mm	50.0–52.0	62970	63113
52mm	51.0–53.0	62972	63114
53mm	52.0–54.0	62974	63115
54mm	53.0–55.0	62976	63116
55mm	54.0–56.0	62978	63117
56mm	55.0–57.0	62980	63118
57mm	56.0–58.0	62982	63119
58mm	57.0–59.0	62984	63120
59mm	58.0–60.0	62986	63121
60mm	59.0–61.0	62988	63122
61mm	60.0–62.0	62990	63123
62mm	61.0–63.0	62992	63124
63mm	62.0–64.0	62994	63125
64mm	63.0–65.0	62996	63126
65mm	64.0–66.0	62998	63127
66mm	65.0–67.0	63000	63128
67mm	66.0–68.0	63002	63129
68mm	67.0–69.0	63004	63130
69mm	68.0–70.0	63006	63131
70mm	69.0–71.0	63008	63132
71mm	70.0–72.0	63010	63133
72mm	71.0–73.0	63012	63134
73mm	72.0–74.0	63014	63135

NOMINAL SIZE	RANGE (mm)	SMOOTH PART NUMBER	SERRATED PART NUMBER
74mm	73.0–75.0	63016	63136
75mm	74.0–76.0	63018	63137
76mm	75.0–77.0	63020	63138
77mm	76.0–78.0	63022	63139
78mm	77.0–79.0	63024	63140
79mm	78.0–80.0	63026	63141
80mm	79.0–81.0	63028	63142
81mm	80.0–82.0	63030	63143
82mm	81.0–83.0	63032	63144
83mm	82.0–84.0	63034	63145
84mm	83.0–85.0	63036	63146
85mm	84.0–86.0	63038	63147
86mm	85.0–87.0	63040	63148
87mm	86.0–88.0	63042	63149
88mm	87.0–89.0	63044	63150
89mm	88.0–90.0	63046	63151
90mm	89.0–91.0	63048	63152
91mm	90.0–92.0	63050	63153
92mm	91.0–93.0	63052	63154
93mm	92.0–94.0	63054	63155
94mm	93.0–95.0	63056	63156
95mm	94.0–96.0	63058	63157
96mm	95.0–97.0	63060	63158
97mm	96.0–98.0	63062	63159
98mm	97.0–99.0	63064	63160
99mm	98.0–100.0	63066	63161
100mm	99.0–101.0	63068	63162

*Royal QG-100 collets have six segments instead of three for increased gripping torque.

Royal QG-100 Hex Collets* – \$1,120 Each

NOMINAL SIZE	RANGE (INCHES)	PART NUMBER
3/4"	0.710–0.790	44904
7/8"	0.835–0.915	44906
1"	0.960–1.040	44908
1 1/8"	1.085–1.165	44910
1 1/4"	1.210–1.290	44912
1 3/8"	1.335–1.415	44914
1 1/2"	1.460–1.540	44916

NOMINAL SIZE	RANGE (INCHES)	PART NUMBER
1 5/8"	1.585–1.665	44918
1 3/4"	1.710–1.790	44920
1 7/8"	1.835–1.915	44922
2"	1.960–2.040	44924
2 1/8"	2.085–2.165	44926
2 1/4"	2.210–2.290	44928
2 3/8"	2.335–2.415	44930

NOMINAL SIZE	RANGE (INCHES)	PART NUMBER
2 1/2"	2.460–2.540	44932
2 5/8"	2.585–2.665	44934
2 3/4"	2.710–2.790	44936
2 7/8"	2.835–2.915	44938
3"	2.960–3.040	44940
3 1/8"	3.085–3.165	44942
3 1/4"	3.210–3.290	44944

*Royal QG-100 collets have six segments instead of three for increased gripping torque.

Royal QG-100 Square Collets* – \$1,120 Each

NOMINAL SIZE	RANGE (INCHES)	PART NUMBER
1"	0.960–1.040	44950
1 1/8"	1.085–1.165	44952
1 1/4"	1.210–1.290	44954
1 3/8"	1.335–1.415	44956
1 1/2"	1.460–1.540	44958

NOMINAL SIZE	RANGE (INCHES)	PART NUMBER
1 5/8"	1.585–1.665	44960
1 3/4"	1.710–1.790	44962
1 7/8"	1.835–1.915	44964
2"	1.960–2.040	44966
2 1/8"	2.085–2.165	44968

NOMINAL SIZE	RANGE (INCHES)	PART NUMBER
2 1/4"	2.210–2.290	44970
2 3/8"	2.335–2.415	44972
2 1/2"	2.460–2.540	44974
2 5/8"	2.585–2.665	44976
2 3/4"	2.710–2.790	44978

*Royal QG-100 collets have six segments instead of three for increased gripping torque.

Royal QG-100 Emergency Collets* – \$970 Each – See Page 38



ROYAL QUICK-GRIP™ EMERGENCY COLLETS

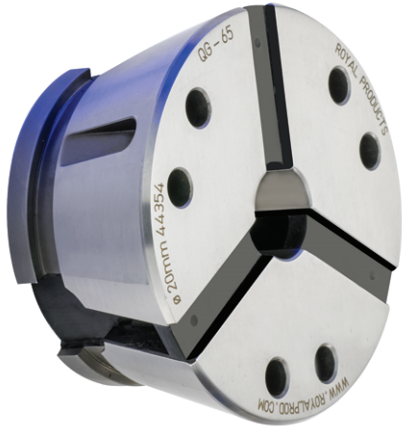

- Semi-hard Quick-Grip™ emergency collets are designed to be machined in-place by the user to **accommodate special sizes, shapes, steps, etc.**
- Available in assorted pilot hole sizes to minimize machining time.
- Collets can be counter-bored beyond standard capacity, **eliminating the need for a three-jaw chuck on many jobs.** The chart below provides some basic counter-bore guidelines, but many other diameter/depth combinations are possible. Please contact Royal for additional information.
- Boring fixture holds collet segments firmly in-place and puts collet under slight compression to ensure accuracy and roundness during machining. Order fixture separately.

Royal Quick-Grip™ Emergency Collets

FITS CHUCK MODEL	PILOT HOLE SIZE	PART NUMBER	PRICE
QG-42	5mm (0.20")	44187	\$348
	15mm (0.59")	44188	348
QG-52	8mm (0.31")	44395	348
	15mm (0.59")	44396	348
QG-65	8mm (0.31")	44353	391
	20mm (0.79")	44354	391
	30mm (1.18")	44355	391
QG-80	8mm (0.31")	44360	590
	20mm (0.79")	44361	590
	40mm (1.57")	44362	590
QG-100	30mm (1.18")	44367	970
	45mm (1.77")	44368	970
	65mm (2.56")	44369	970



Royal Boring Fixtures

COLLET MODEL	PART NUMBER	PRICE
QG-42	44082	\$224
QG-52	44094	224
QG-65	44083	313
QG-80	44088	516
QG-100	44089	620

Royal Quick-Grip™ Collet Counter-Bore Guidelines

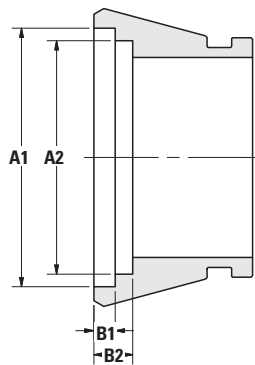

- The parameters shown represent a sampling of counter-bore possibilities. Other diameter/depth combinations are possible. Please contact Royal with your specific requirements.
- For precise z-axis positioning, best practice is to use a Royal stop.
- Users can counter-bore their own emergency collets, or **order to size as hardened and ground specials.**
- For a better understanding of counter-bore collets and their use, please contact one of our applications engineers at 1-800-645-4174.

COLLET MODEL	A1	B1	A2	B2
QG-42	2.62	0.28	2.53	0.39
QG-52	2.57	0.28	2.49	0.50
QG-65	3.40	0.28	3.07	0.51
QG-80	4.00	0.28	3.66	0.51
QG-100	5.15	0.28	4.61	0.79

ROYAL CUSTOM QUICK-GRIP™ COLLETS



In addition to the thousands of standard Quick-Grip™ Collets we stock for same-day shipping, Royal also offers extensive design and manufacturing services for **custom collets to suit unique workpiece shapes**. The two main applications for custom collets are:

- Second-op turning where the gripping surface is not cylindrical.
- Milling applications where a Royal Power-Block™ Collet Fixture provides a superior workholding solution over conventional vises and prismatic fixtures.

Shown below are a few examples to highlight some of our capabilities. Please give one of our applications engineers a call today to discuss how **custom Quick-Grip™ Collets can help optimize your manufacturing processes**.

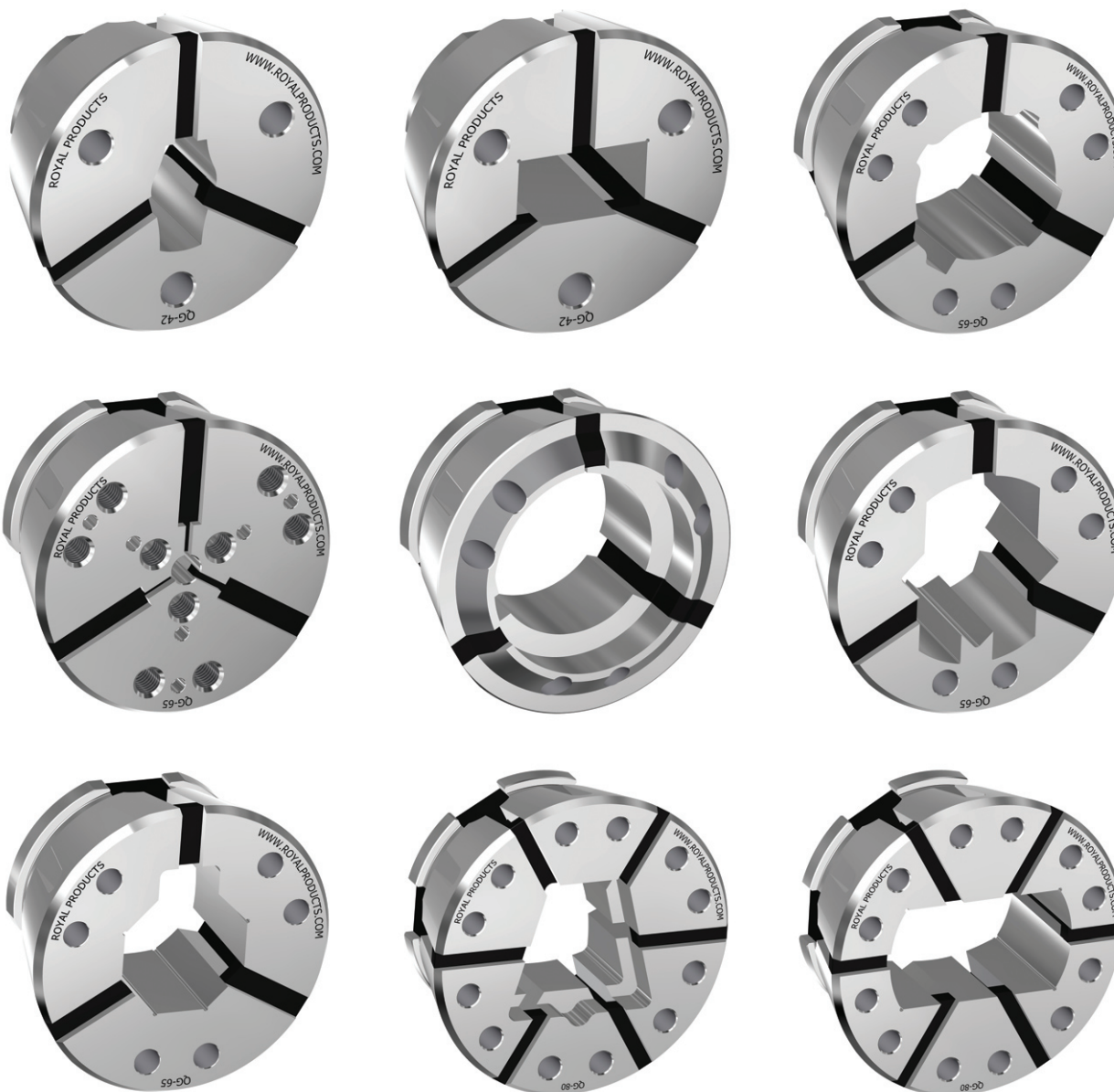

Have a Question? Give One of Our Engineers a Call at 1-800-645-4174



ROYAL QUICK-GRIP™ S-TYPE MASTER COLLETS

Occasionally, customers express interest in using S-type collet pads to grip their parts. Although this outdated technology is typically not the best choice for most workholding applications, S-type collet pads can be utilized with Royal Quick-Grip™ CNC Collet Chucks via our Quick-Grip™ S-Type Master Collets. These master collets are available for Royal QG-65 and QG-80 chuck models, and are capable of accepting S-20, S-26, and S-30 collet pads.

- Three master collet models to choose from:
 - QG-65 Master Collet – accepts S-20 collet pads (2" capacity)
 - QG-80 Master Collet – accepts S-26 collet pads (2-5/8" capacity)
 - QG-80 Master Collet – accepts S-30 collet pads (3" capacity)
- **It is important to note that the master collet must be installed in the chuck prior to pad installation, thereby mitigating the system's quick-change advantage.**
- Royal QG-80 master collets contain four segments instead of our traditional six, requiring the use of a special four-segment changing tool (sold separately below). The model 65 utilizes the same installation tool as our standard QG-65 collets.
- Due to the stacking of tolerances and complex geometry, **the use of S-type collet pads will result in a significant reduction in accuracy.** Most S-pad manufacturers will not guarantee their pads to run better than 0.001" – 0.0025" TIR. By contrast, Royal hardened and ground Quick-Grip™ collets are guaranteed accurate to 0.0002" TIR.
- The use of S-type pads reduces overall Quick-Grip™ chucking capacity. See chart below.



The Bottom Line

Using S-Type Collet Pads in a Royal Quick-Grip™ Collet Chuck may come in handy for some jobs, but their use will eliminate the quick-change feature and cause a reduction in both gripping capacity and overall system accuracy.

For the highest accuracy, best performance, and full Quick-Grip™ functionality, it is always best to utilize hardened and ground Royal Quick-Grip™ Collets.

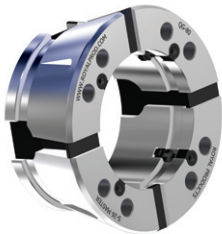

Royal Quick-Grip™ S-Type Master Collets

CHUCK MODEL	S-TYPE PAD MODEL	MAXIMUM PAD CAPACITY*	MASTER COLLET PART NUMBER	PRICE**
QG-65	S-20	2.00	44196	\$633
QG-80	S-26	2.63	44197	909
QG-80	S-30	3.00	44198	909

*Please note – normal thru-capacity is reduced when using S-type master collets and pads.

**S-type pads not included with master collet. Order pads separately through your local tooling supplier.



44199 shown

Royal Collet Installation Tool For Use With Quick-Grip™ S-Type Master Collets

MASTER COLLET MODEL	NUMBER OF SEGMENTS	PART NUMBER	PRICE
QG-65	3	44098	\$598
QG-80	4*	44199*	677

*Please note that the model 80 installation tool is not the same as the one offered for our regular QG-80 collets because our hardened and ground QG-80 collets have six segments while the QG-80 master collet has four segments.



ROYAL BRINGS INCREASED PRODUCTIVITY DIRECTLY TO YOUR COMPANY PARKING LOT



Not Able to Visit a Tradeshow?

No problem – with Royal's nationwide fleet of fully-equipped mobile showrooms, **we can bring the show right to your company parking lot.**

Each of our demo vans is outfitted with dozens of productivity-enhancing CNC metalworking accessories that you and your team can see/touch/try firsthand, and then determine for yourselves how they might bring value to your company.

Schedule your visit today at royalproducts.com



UNSURE? ROYAL HAS YOU COVERED!

With Royal's exclusive Risk-Free Performance Guarantee, **you can try many of our products on the toughest jobs in your shop for 45-days**, and if you aren't 100% satisfied with the performance, we'll take it back and arrange for a full refund.

How can we offer such a guarantee? It's simple – our products are all designed and built to outperform expectations, and very few customers are ever disappointed.

We understand that implementing new technology can be scary, and we are happy to alleviate your concerns by removing the risk.

Call us today at 1-800-645-4174 to find out more.