

# TURN-KEY FILTERMIST INSTALLATION FOR OKUMA MACHINING CENTERS

**NEW**



FX-575  
Shown

*Easily Add Royal Filtermist to the Okuma M460 and M560!*

Royal Filtermist Advantages:

- ✓ Low Cost
- ✓ Quick Installation
- ✓ Highly Efficient
- ✓ Minimal Maintenance
- ✓ Risk-Free Performance Guarantee

## CHOOSE YOUR SETUP

### Standard Pressure (Factory Coolant Pump)

Part Number	Description	Price
30115PROMO	Filtermist FX-575	\$3,795
30329	Okuma Mounting Bracket	\$982
30470	208/230V Starter Box Kit*	\$717
30471	460V Starter Box Kit*	
<b>Total Price:</b>		\$5,494

### High Pressure (Aftermarket Coolant Pump)

Part Number	Description	Price
30120PROMO	Filtermist FX-900	\$4,695
30329	Okuma Mounting Bracket	\$982
30472	208/230V Starter Box Kit*	\$717
30473	460V Starter Box Kit*	
<b>Total Price:</b>		\$6,394

\*Choose one Starter Box Kit based upon voltage in your shop.

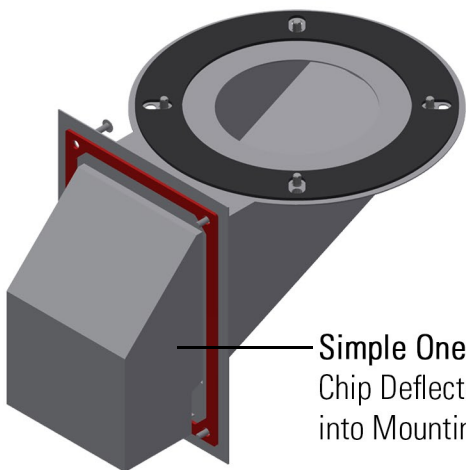

Simple One-Piece Design  
Chip Deflector directly integrated  
into Mounting Bracket